

 **BHH MIKROMED 4vet**

---



**WETERYNARIA**

---

**VETERINARY**

BHH Mikromed sp. z o.o. zastrzega sobie prawo do wprowadzania zmian, wygląd produktu może nieznacznie różnić się od przedstawionego na ilustracji  
Wszystkie treści, materiały oraz elementy graficzne umieszczone w tym dokumencie są własnością intelektualną firmy BHH Mikromed sp. z o.o.

BHH Mikromed Sp. z o.o. reserves the right to make changes, the design of the product may slightly differ from the picture.  
All content, materials and graphic elements placed in this document are the intellectual property of BHH Mikromed Sp. z o.o.

## SPIS TREŚCI / CONTENT

PŁYTKA DO STAWU SKOKOWEGO/ PLATE FOR MEDIAL PANTARSAL ARTHRODESIS .....	3
PŁYTKA SIATKOWA/ MESH PLATE .....	4
WKRĘT DO WYROSTKA ŁOKCIOWEGO N-FIX/ N-FIX SCREW FOR OLECRANON .....	5
PŁYTKA DO KOREKCJI NASAD KOŚCI PISZCZELOWYCH W FAZIE WZROSTU/ PLATE FOR CORRECTION OF TIBIA EPIPHYSIS IN THE GROWT PHASE .....	6
PODKŁADKA DO WIĘZADŁA KRZYŻOWEGO/ WASHER FOR ACL CRUCIATE LIGAMENT .....	7
GROTOWKRĘTY SCHANZA Z POZYTYWNYM GWINTEM/ SCHANZ SCREW WITH POSITIVE THREAD ..	8
TTA .....	9
GWOŹDZIE BLOKOWANE N-LOCK/ N-LOCK INTERLOCKING NAILS .....	13
PŁYTKI TPO/ TPO PLATES .....	18
PŁYTKI TPLO/ TPLO PLATES .....	19
SYSTEM PŁYTEK KOMPRESYJNO-BLOKOWANYCH/ LOCKING - COMPRESSION PLATE SYSTEM .....	21
PŁYTKI PROSTE/ STRAIGHT PLATES .....	32
PŁYTKI KSZTAŁTOWE/ SHAPED PLATES.....	36
PŁYTKI REKONSTRUKCYJNE/ RECONSTRUCTION PLATES .....	39
WKRĘTY/ SCREWS .....	41
PODKŁADKI/ WASHERS .....	45
DRUTY/ WIRES .....	46
GROTOWKRĘTY/ PINS .....	49
SYSTEM ZESPOL.....	50
INSTRUMENTY/ INSTRUMENTS.....	62
WKRĘTAKI/ SCREWDRIVERS .....	62
WIERTŁA/ DRILLS.....	62
PROWADNIKI/ GUIDES .....	63
GWINTOWNIKI/ TAPS .....	64
OSŁONY GWINTOWNIKÓW/ TAP SLEEVES.....	64
MIARKI/ GAUGES.....	65
WYGINAKI/ BENDING INSTRUMENTS .....	65
KLESZCZE/ FORCEPS .....	66
UCHWYTY/ HANDLES.....	66
INNE/ OTHERS .....	67
DOBÓR KĄTA TPLO TPLO ROTATION – REFERENCE CHART .....	68
DOBÓR IMPLANTÓW TTA SELECTION OF TTA IMPLANTS .....	70
REKOMENDOWANE NARZĘDZIA DO IMPLANTACJI WKRĘTÓW BHH MIKROMED RECOMMENDED INSTRUMENTS FOR BHH MIKROMED SCREWS IMPLANTATION.....	72
TABELA DOBORU ŚREDNICY WKRĘTA WZGLĘDEM WAGI PACJENTA CHART OF SCREW DIAMETER RELATIVE TO PATIENTS WEIGHT .....	74
SPIS OZNACZEŃ KOLORYSTYCZNYCH NARZĘDZI SYSTEMÓW PŁYTEK BLOKOWANYCH COLOUR CODING OF LOCKING SYSTEM INSTRUMENTS.....	76



Dołącz do  
nas na  
facebooku

mikromed - weterynaria



PŁYTKA DO STAWU SKOKOWEGO /  
PLATE FOR MEDIAL PANTARSAL ARTHRODESIS

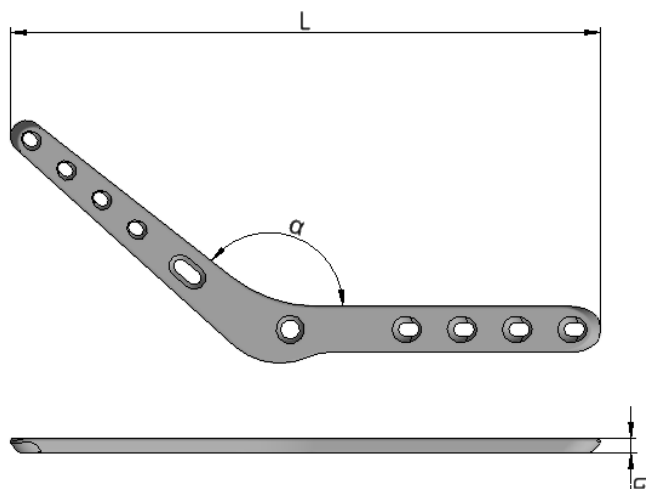

α [°]	L [mm]	G [mm]	Pod wkręty For screws	Nr katalogowy/ Cat No	
				Lewa/ Left	Prawa/ Right
120°	68	1,5	2,0 -2,7	010316	010315
135°	74	1,5	2,0 – 2,7	010318	010317
135°	97	2,0	2,0 – 2,7	010352	010350
140°	128	3,0	2,0 – 2,7	010356	010354
140°	128	3,0	2,7 – 3,5	010360	010358
140°	145	3,0	2,7 – 3,5	010364	010362
140°	185	3,0	2,7 - 4,5	010368	010366

## PŁYTKA SIATKOWA/ MESH PLATE

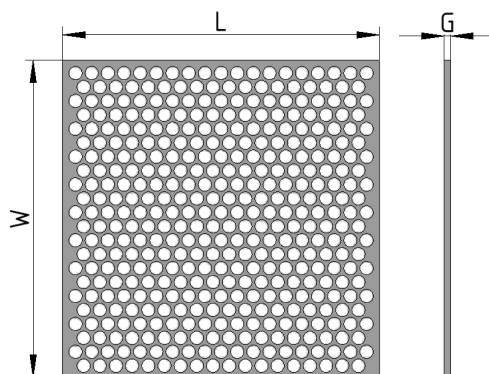

L x W [mm]	G [mm]	Zalecane wkręty Recommended screws	Nr katalogowy/ Cat No
			Ti
49 x 49	0,5	Ø2,0mm	019101T
	1,0		019111T
70 x 70	0,5	Ø2,4 - Ø 2,7mm	019102T
	1,0		019112T
90 x 90	0,5	Ø2,4 - Ø 2,7mm	019103T
	1,0		019113T

**WKREĆ DO WYROSTKA ŁOKCIOWEGO N-FIX/  
N-FIX SCREW FOR OLECRANON**

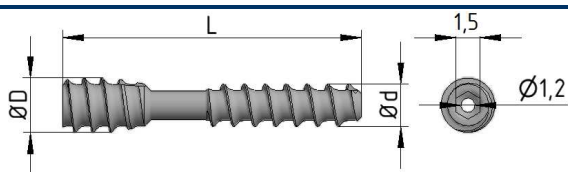

**Wkręt do wyrostka łokciowego N-fix**  
N-fix screw for olecranon

L [mm]	ØD [mm]	Ød [mm]	Nr katalogowy Cat No	
			SS	Ti
20	3,5	3,0	025120	025120T
25			025125	025125T
30			025130	025130T
25	4,5	3,5	025025	025025T
30			025030	025030T
35			025035	025035T
40			025040	025040T

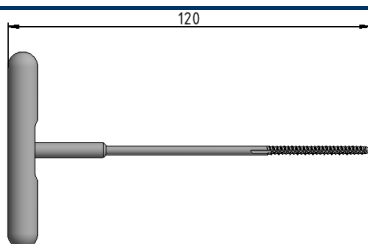

**Gwintownik do wkrętów N-fix**  
Tap for N-fix screws

Dla wkrętów For screws	Nr katalogowy Cat No
Ø3,5/Ø3,0	072130
Ø4,5/Ø3,5	072135

## PŁYTKA DO KOREKЦИИ NASAD KOŚCI PISZCZELOWYCH W FAZIE WZROSTU/ PLATE FOR CORRECTION OF TIBIA EPIPHYSIS IN THE GROWTH PHASE

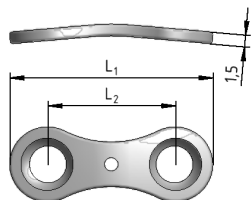

**Płytki do korekcji nasad kości piszczelowych w fazie wzrostu**  
Plate for correction of tibia epiphysis in the growth phase

Dł. wkrętów For screws	L <sub>1</sub> [mm]	L <sub>2</sub> [mm]	Nr katalogowy/ Cat No
Ø4,5	21	12	010572T
	25	16	010576T

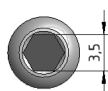
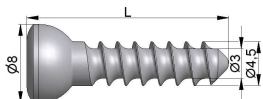

**Wkręt do kości korowej Ø4,5/3,0mm**  
Cortex screw Ø4,5/3,0mm

L [mm]	Nr katalogowy/ Cat No	
12	200212T	200512T
14	200214T	200514T
16	200216T	200516T
18	200218T	200518T
20	200220T	200520T
22	200222T	200522T
24	200224T	200524T
26	200226T	200526T
28	200228T	200528T
30	200230T	200530T
32	200232T	200532T
34	200234T	200534T
36	200236T	200536T

L [mm]	Nr katalogowy/ Cat No	
38	200238T	200538T
40	200240T	200540T
42	200242T	200542T
44	200244T	200544T
46	200246T	200546T
48	200248T	200548T
50	200250T	200550T
52	200252T	200552T
54	200254T	200554T
56	200256T	200556T
58	200258T	200558T
60	200260T	200560T

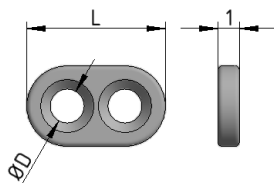

**PODKŁADKA DO WIĘZADŁA KRZYŻOWEGO /  
WASHER FOR ACL CRUCIATE LIGAMENT**

L [mm]	ØD [mm]	Nr katalogowy/ Cat No
6,5	1,6	292240
9,0	2,0	292250

## GROTOWKRĘTY SZANZA Z POZYTYWNYM GWINTEM/ SCHANZ SCREW WITH POSITIVE THREAD

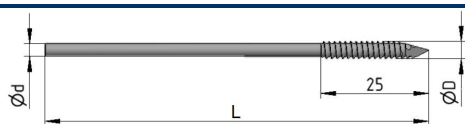

**Grotowkręt Schanza z pozytywnym gwintem**  
Schanz screw with positive thread

øD [mm]	ød [mm]	L [mm]	Nr kat/ Cat No	
			SS	
Ø2,0	Ø1,6	89	362820	
Ø3,5	Ø2,4	89	362835	
Ø4,0	Ø2,9	127	362840	

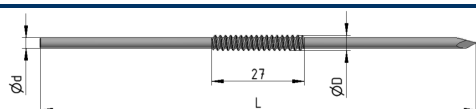

**Grotowkręt Schanza z centralnym gwintem**  
Schanz screw with central thread

øD [mm]	ød [mm]	Nr kat/ Cat No	
		SS	
		L [mm]	
		127	177
Ø2,0	Ø1,6	362922	362927
Ø3,5	Ø2,2	362932	362937
Ø4,0	Ø3,0	362942	362947

TTA

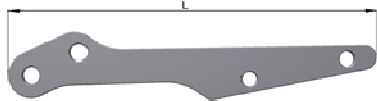

**Płytką TTA (1.0 mm grubości)**  
TTA plate (1.0 mm thickness)

L [mm]	Ilość otworów bliższych/dalszych Holes proximal/distal	Zalecane wkręty [mm] Recommended screws [mm]	Nr katalogowy Cat No	
			SS	Ti
41	2 / 2	2,4 / 2,7	090436	090436T
51	2 / 2	2,4 / 2,7	090438	090438T
64	2 / 2	2,4 / 2,7	090440	090440T
77	3 / 2	2,4 / 3,5	090442	090442T
90	3 / 2	2,4 / 3,5	090444	090444T
107	3 / 2	2,4 / 3,5	090446	090446T

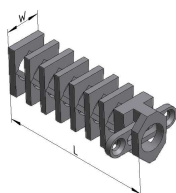

**Kostka TTA z możliwością docinania długości**  
TTA cage with possibility to cut the length

W [mm]	L [mm]	Dla wkrętów [mm]* For screws [mm]*	Nr katalogowy Cat No	
			SS	Ti
6	26	Ø2,4	090420	090420T
7.5	26		090422	090422T
9	29	Ø2,7	090424	090424T
10.5	29		090426	090426T
12	32		090428	090428T
13.5	32		090430	090430T
15	35		090432	090432T
16	35		090434	090434T

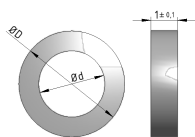

**Podkładka dystansowa**  
Spacer

ØD [mm]	Ød [mm]	Dla kostki TTA For TTA cage	Nr katalogowy Cat No	
			SS	Ti
4,0	2,5	090420 090422	029012	029012T
5,0	2,8	090424 090426 090428 090430 090432 090434	029014	029014T

\*Asortyment wkrętów Ø2,4 Ø2,7 Ø3,5 dostępny na stronach 41-42.  
\*See Ø2,4 Ø2,7 Ø3,5 screws on pages 41-42.

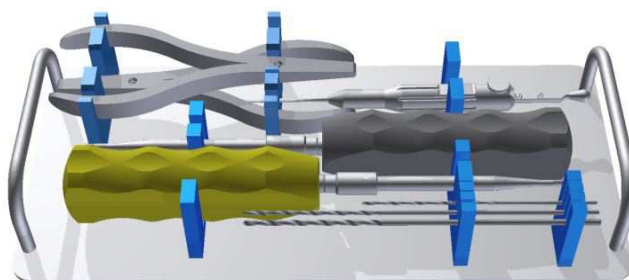
TTA – ZESTAW INSTRUMENTÓW  
TTA – INSTRUMENTS SET

Lp.	Nazwa elementu / Description	Nr katalogowy/ Cat No.	Ilość Pcs
1	Wyginak płytek drobnych Bending pliers for small plates	470020	2
2	Miarka głębokości L=50mm Depth gauge L=50mm	772030	1
3	Wkrętak heksagonalny S=2,0mm Hexagonal screwdriver S=2,0mm	781201	1
4	Wkrętak heksagonalny S=2,5mm Hexagonal screwdriver S=2,5mm	781200	1
5	Wiertło Ø1,5x100mm Drill Ø1,5x100mm	711015	1
6	Wiertło Ø2,0x150mm Drill Ø2,0x150mm	711020	1
7	Wiertło Ø2,5x150mm Drill Ø2,5x150mm	711025	1
9	Kleszcze do ucinania kostek TTA Forceps for TTA cages cutting	440010	1
8	Paleta na instrumentarium TTA Tray for TTA instruments	540032	1
<b>Elementy dodatkowe / Additional elements</b>			
9	Wkrętak dynamometryczny S2.0 Torque limiting screwdriver S2.0	783120	opcjonalnie optional
10	Wkrętak dynamometryczny S2.5 Torque limiting screwdriver S2.5	783125	opcjonalnie optional
11	Paleta na implanty TTA wraz ze statywem na wkręty Tray for TTA implants with stand for screws	540025	opcjonalnie optional
12	Kaseta sterylizacyjna Sterilization container	540016	opcjonalnie optional

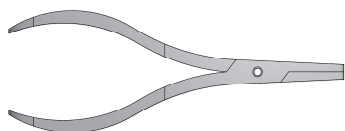

**Wyginak do płytek drobnych**  
Bending pliers for small plates

Nr katalogowy/ Cat No

470020



**Miarka głębokości L=50mm**  
Depth gauge L=50mm

Nr katalogowy/ Cat No

772030



**Wkrętak heksagonalny**  
Hexagonal screwdriver

Ø wkręta Ø of screw	S [mm]	Nr katalogowy/ Cat No
2,4	2,0	781201
2,7-4,0	2,5	781200

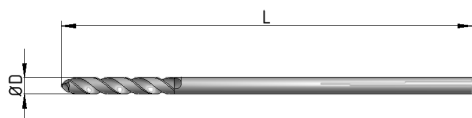

**Wiertło**  
Drill

ØD [mm]	L [mm]	Nr katalogowy/ Cat No
Ø1,5	100	711015
Ø2,0	150	711020
Ø2,5	150	711025

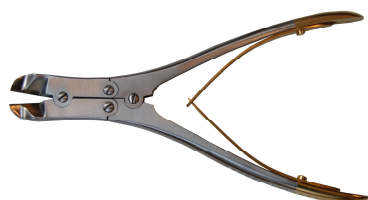

**Kleszcze do ucinania kostek TTA**  
Forceps for TTA cages cutting

Nr katalogowy/ Cat No

440010

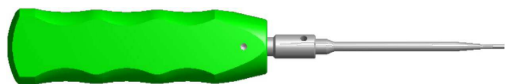

**Wkrętak dynamometryczny**  
Torque limiting screwdriver

Ø wkręta Ø of screw	S [mm]	Nr katalogowy/ Cat No
2,4	2,0	783120
2,7-4,0	2,5	783125

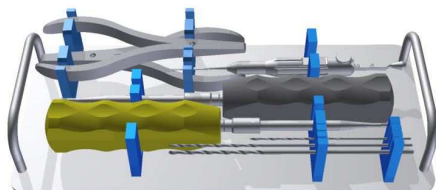

**Paleta na instrumentarium TTA (bez narzędzi)**  
Tray for TTA instruments (without implants)

Kaseta sterylizacyjna/ Sterilization container	Nr katalogowy/ Cat No
540016	540032

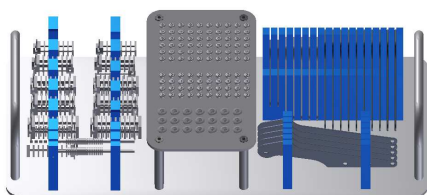

**Paleta na implanty TTA wraz ze statywem na wkręty (bez implantów)**  
Tray for TTA implants with stand for screws  
(without implants)

Kaseta sterylizacyjna/ Sterilization container	Nr katalogowy/ Cat No
540016	540025

## GWOŹDZIE BLOKOWANE N-LOCK/ N-LOCK INTERLOCKING NAILS

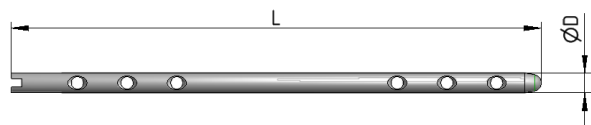

Gwoździe weterynaryjne  
Veterinary nail

L [mm]	Nr katalogowy / Catalogue No					
	øD = 6 mm		øD = 7 mm		øD = 8 mm	
	SS	Ti	SS	Ti	SS	Ti
130	031613	031613T	031713	031713T	031813	031813T
145	031614	031614T	031714	031714T	031814	031814T
160	031616	031616T	031716	031716T	031816	031816T
175	031617	031617T	031717	031717T	031817	031817T
190	031619	031619T	031719	031719T	031819	031819T
205	031620	031620T	031720	031720T	031820	031820T
220	031622	031622T	031722	031722T	031822	031822T

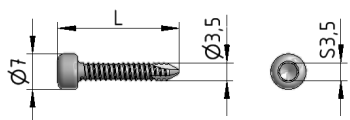

Wkręt blokujący Ø3,5mm pełnogwintowany, samogwintujący  
Locking screw Ø3,5mm, fully threaded, self-tapping

L [mm]	Nr kat/ Cat No	
	SS	Ti
20	294454	294454T
22	294456	294456T
24	294458	294458T
25	294459	294459T
26	294460	294460T
28	294462	294462T
30	294464	294464T

L [mm]	Nr kat/ Cat No	
	SS	Ti
32	294466	294466T
34	294468	294468T
35	294469	294469T
36	294470	294470T
38	294472	294472T
40	294474	294474T



Wkręt zaślepiający M4  
End cap

Do gwoździ	Nr kat/ Cat No	
	SS	Ti
Ø8	029000	029000T
Ø7	029020	029020T
Ø6	029010	029010T

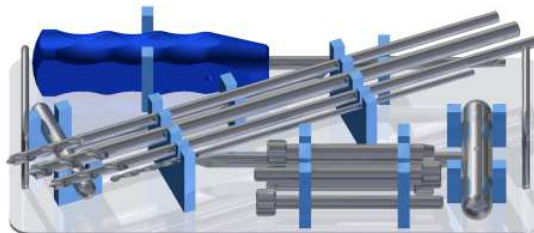
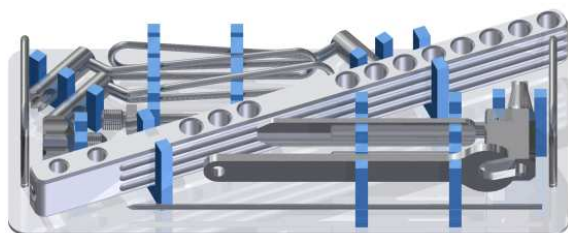
**GWOŹDZIE WETERYNARYJNE- ZESTAW INSTRUMENTÓW**  
**VETERINARY NAILS – INSTRUMENTS SET**

Lp.	Nazwa elementu / Description	Nr katalogowy/ Cat No.	Ilość Pcs
1	Prowadnica do gwoździ weterynaryjnych – komplet Veterinary targeting device - set	075300	1
2	Trokar Ø3,0mm Trocar Ø3,0mm	079006	1
3	Trokar Ø8,0mm Trocar Ø8,0mm	079060	1
4	Wiertło Ø3,0mm Drill Ø3,0mm	711930	1
5	Wiertło Ø6,0mm Drill Ø6,0mm	071206	1
6	Wiertło Ø7,0mm Drill Ø7,0mm	071207	1
7	Wiertło Ø8,0mm Drill Ø8,0mm	071208	1
8	Kluczek płaski S13 Flat wrench S13	761330	1
9	Wkrętak heksagonalny S3.5 Hexagonal screwdriver S3.5	782200	1
10	Tuleja wiertarska Ø3,0mm Drill sleeve Ø3,0mm	075193	2
11	Tuleja ochronna Ø7,0mm Protection sleeve Ø7,0mm	075194	2
12	Miarka długości wkrętów Length gauge for screws	770115	1
13	Tuleja wiertarska Ø6,0mm Protection sleeve Ø6,0mm	075051	1
14	Tuleja wiertarska Ø7,0mm Protection sleeve Ø7,0mm	075052	1
15	Tuleja wiertarska Ø8,0mm Protection sleeve Ø8,0mm	075053	1
16	Wbijak – wybijak Impactor - extractor	075320	1
17	Drut Kirschnera M3x200mm Kirschner Wire M3x200mm	313004	2
18	Paleta 1 Tray 1	540040	1
19	Paleta 2 Tray 2	540041	1
<b>Elementy dodatkowe / Additional elements</b>			
20	Paleta na gwoździe weterynaryjne Ø6.0mm Tray for veterinary nails Ø6.0mm	540046	Opcjonalnie Optional
21	Paleta na gwoździe weterynaryjne Ø7.0mm Tray for veterinary nails Ø7.0mm	540047	Opcjonalnie Optional
22	Paleta na gwoździe weterynaryjne Ø8.0mm Tray for veterinary nails Ø8.0mm	540048	Opcjonalnie Optional
23	Kaseta sterylizacyjna Sterilization container	540016	opcjonalnie optional





Prowadnica do gwoździ weterynaryjnych – komplet  
Veterinary targeting device - set

Nr katalogowy/ Cat No

075300



Trokar  
Trocar

ØD [mm]	Nr katalogowy/ Cat No
Ø3,0	079006
Ø8,0	079060

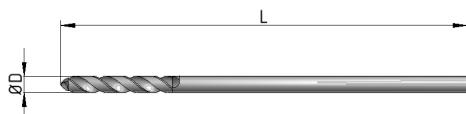

Wiertło  
Drill

ØD [mm]	L [mm]	Nr katalogowy Cat No.
Ø3,0	200	711930
Ø6,0	270	071206
Ø7,0	270	071207
Ø8,0	270	071208



Klucz płaski S13  
Flat wrench S13

Nr katalogowy/ Cat No

761330



**Wkrętak heksagonalny S3,5 lity**  
Hexagonal screwdriver S3,5 solid

L [mm]	S [mm]	Nr katalogowy/ Cat No
120	3,5	782200



**Tuleja wiertarska Ø3,0mm**  
Drill sleeve Ø3,0mm

Nr katalogowy/ Cat No

075193



**Tuleja ochronna Ø7,0mm**  
Protection sleeve Ø7,0mm

Nr katalogowy/ Cat No

075194

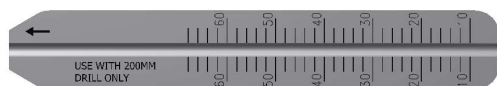

**Miarka długości wkrętów**  
Length gauge for screws

Nr katalogowy/ Cat No

770115

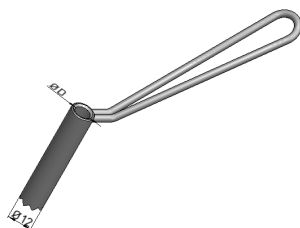

**Tuleja ochronna**  
Protection sleeve

ØD [mm]	Nr katalogowy/ Cat No
6,0	075051
7,0	075052
8,0	075053

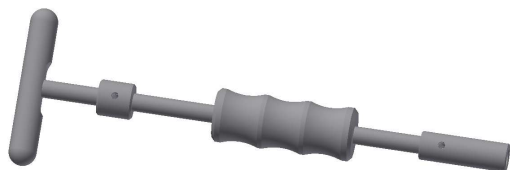

**Wbijak - wybijk**  
Impactor - extractor

Nr katalogowy/ Cat No

075320

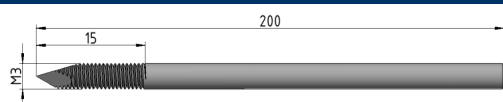

**Drut Kirschnera M3x200mm**  
Kirschner Wire M3x200mm

Nr katalogowy/ Cat No

313004

**Palety sterylizacyjne do zestawu narzędzi do gwoździ weterynaryjnych (bez narzędzi)**  
Sterilization trays for set of instruments for veterinary nail (without instruments)

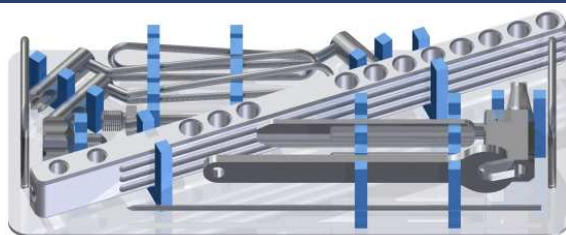

Paleta 1/ Tray 1

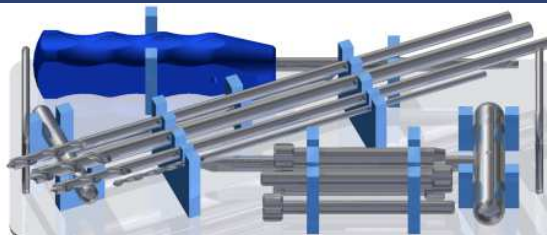

Paleta 2/ Tray 2

Nazwa/ Description	Kaseta sterylizacyjna/ Sterilization container	Nr katalogowy/ Cat No
Paleta 1 Tray 1	540016	540040
Paleta 2 Tray 2	540016	540041

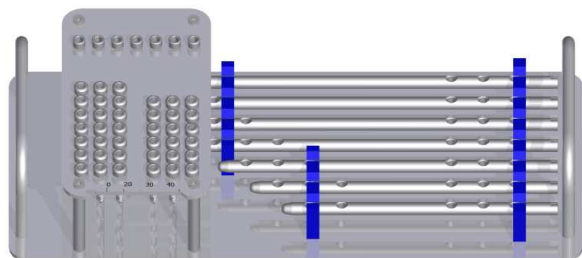

**Paleta na gwoździe i wkręty (bez implantów)**  
Tray for nails and screws (without implants)

Dla gwoździ For nails	Kaseta sterylizacyjna/ Sterilization container	Nr katalogowy/ Cat No
Ø6,0	540016	540046
Ø7,0	540016	540047
Ø8,0	540016	540048

## PŁYTKI TPO / TPO PLATES

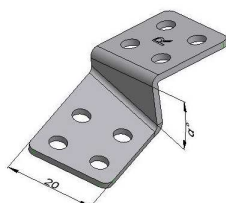

Płytki TPO pod wkręty  $\varnothing 3,5$  mm i  $\varnothing 4,0$  mm i  $\varnothing 4,5$  mm  
TPO plates for screws  $\varnothing 3,5$  mm and  $\varnothing 4,0$  mm and  $\varnothing 4,5$  mm

$\alpha$ [°]	Ilość otworów Holes	L [mm]	Nr katalogowy/ Cat No			
			$\varnothing$ of screw=3,5mm/ $\varnothing$ of screw=4mm		$\varnothing$ of screw=4,5 mm	
			Lewa/ Left	Prawa/ Right	Lewa/ Left	Prawa/ Right
20	8	55	010220	010221	010320	010321
25	8	55	010225	010226	010325	010326
30	8	55	010230	010231	010330	010331
35	8	55	010235	010236	010335	010336

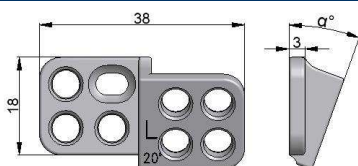

Płytki blokowane TPO / DPO pod wkręty SYSTEM 3,5  
TPO / DPO locking plate for screw SYSTEM 3,5

$\alpha$ [°]	Ilość otworów Holes	Nr katalogowy/ Cat No			
		Lewa / Left		Prawa / Right	
		SS	Ti	SS	Ti
20	7+1	010202	010202T	010208	010208T
25	7+1	010203	010203T	010209	010209T
30	7+1	010204	010204T	010210	010210T
35	7+1	010205	010205T	010211	010211T

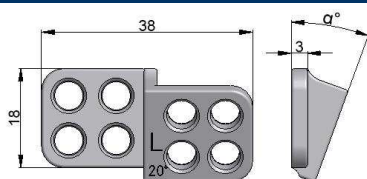

Płytki blokowane TPO /DPO pod wkręty SYSTEM 3,5  
TPO / DPO locking plate for screw SYSTEM 3,5

$\alpha$ [°]	Ilość otworów Holes	Nr katalogowy/ Cat No			
		Lewa/ Left		Prawa/ Right	
		SS	Ti	SS	Ti
20	8	010252	010252T	010258	010258T
25	8	010253	010253T	010259	010259T
30	8	010254	010254T	010260	010260T
35	8	010255	010255T	010261	010261T

PŁYTKI TPLO/ TPLO PLATES

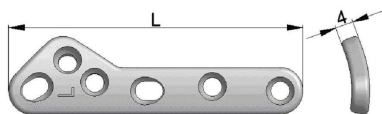

Płytką TPLO pod wkręty  $\varnothing 3,5$  mm i  $\varnothing 4,0$  mm  
TPLO Plate for screws  $\varnothing 3,5$  mm and  $\varnothing 4,0$  mm

Ilość otworów Holes	L [mm]	Nr katalogowy/ Cat No	
		Lewa/ Left	Prawa/ Right
6	55	012720	012710
7	75	012740	012730

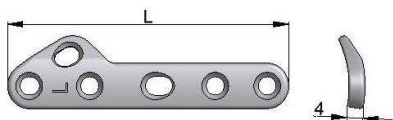

Płytką TPLO pod wkręty  $\varnothing 3,5$  mm i  $\varnothing 4,0$  mm  
TPLO Plate for screws  $\varnothing 3,5$  mm and  $\varnothing 4,0$  mm

Ilość otworów Holes	L [mm]	Nr katalogowy/ Cat No			
		Lewa/ Left		Prawa/ Right	
		SS	Ti	SS	Ti
6	55	012930	012930T	012940	012940T

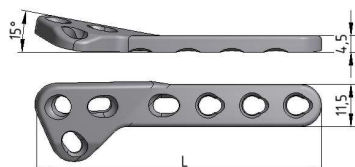

Płytką blokowaną TPLO pod wkręty SYSTEM 3,5  
TPLO locking plate for screw SYSTEM 3,5

Otwory Holes	L [mm]	Nr katalogowy/ Cat No			
		Lewa/ Left		Prawa/ Right	
		SS	Ti	SS	Ti
7	78	012950	012950T	012960	012960T



Płytką blokowaną TPLO pod wkręty SYSTEM 3,5  
TPLO locking plate for screw SYSTEM 3,5

Nr katalogowy/ Cat No			
Lewa/ Left		Prawa/ Right	
SS	Ti	SS	Ti
010217	010217T	010218	010218T

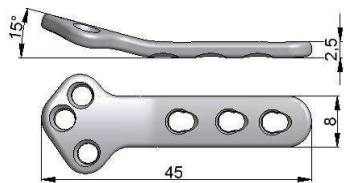

**Płytką blokowaną TPLO pod wkręty SYSTEM 2,4**  
TPLO locking plate for screw SYSTEM 2,4

Nr katalogowy/ Cat No			
Lewa/ Left		Prawa/ Right	
SS	Ti	SS	Ti
010228	010228T	010229	010229T

**SYSTEM PŁYTEK KOMPRESYJNO-BLOKOWANYCH/  
LOCKING - COMPRESSION PLATE SYSTEM**



**Płytki blokowane, kompresyjna rekonstrukcyjna prosta 8,0x1,8mm**  
Reconstruction self-compressing locking plate 8,0x1,8mm

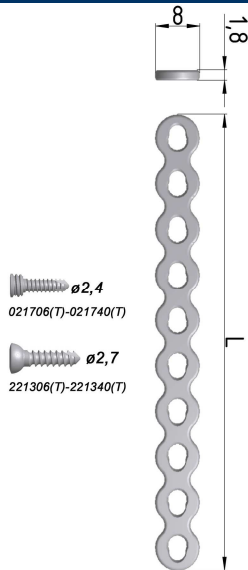

Otwory Holes	L [mm]	Nr katalogowy/ Cat No	
		SS	Ti
6	48	012176	012176T
7	56	012177	012177T
8	64	012178	012178T
9	72	012179	012179T
10	80	012180	012180T
11	88	012181	012181T
12	96	012182	012182T



**Płytki T blokowane pod wkręty SYSTEM 3,5**  
T locking plate for screws SYSTEM 3,5

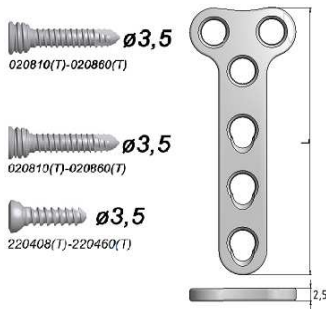

Ilość otworów Holes	L [mm]	Nr katalogowy/ Cat No
		Ø of screw=3,5mm
2/4	54	012454
2/5	76	012476

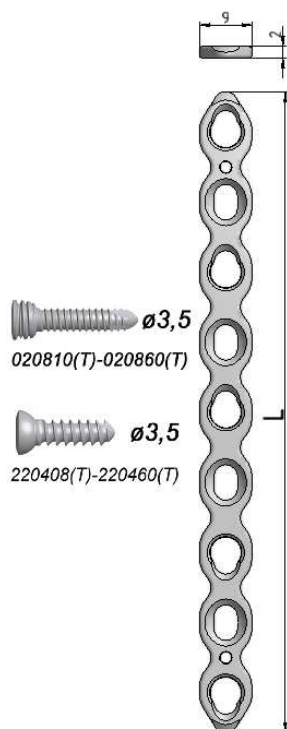
**3,5 SYSTEM***Mikromed Locking Plates***Płytki blokowane rekonstrukcyjna 9,0x2,2mm**  
Reconstruction locking plate 9,0x2,2mm

Otwory Holes	L [mm]	Nr katalogowy/ Cat No	
		SS	Ti
6	76	012032	012032T
7	88	012033	012033T
8	100	012034	012034T
9	112	012035	012035T
10	124	012036	012036T
11	136	012037	012037T
12	148	012038	012038T
13	160	012039	012039T

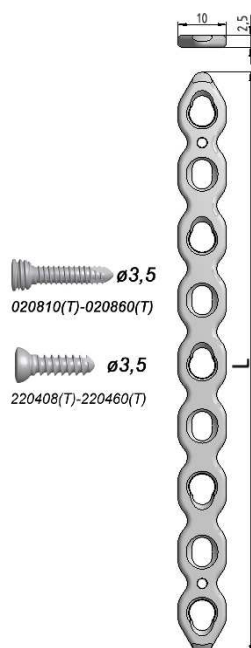
**3,5 SYSTEM***Mikromed Locking Plates***Płytki blokowane rekonstrukcyjna 10,0x2,6**  
Reconstruction locking plate 10,0x2,6

Otwory Holes	L [mm]	Nr katalogowy/ Cat No	
		SS	Ti
6	82	012052	012052T
7	95	012053	012053T
8	108	012054	012054T
9	121	012055	012055T
10	134	012056	012056T
11	147	012057	012057T
12	160	012058	012058T



**3,5 SYSTEM**  
Mikromed Locking Plates

**Płytki blokowane rekonstrukcyjna 11,0x3,0**  
Reconstruction locking plate 11,0x3,0

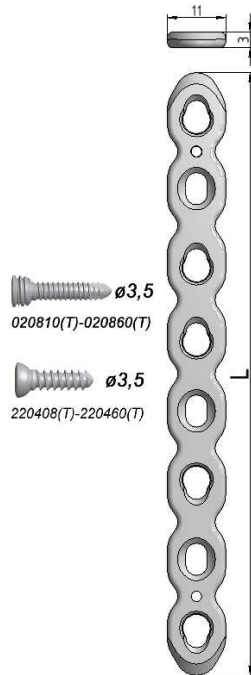

Otwory Holes	L [mm]	Nr katalog	
		SS	Ti
6	88	012072	012072T
7	102	012073	012073T
8	116	012074	012074T
9	130	012075	012075T
10	144	012076	012076T
11	158	012077	012077T
12	172	012078	012078T
13	186	012079	012079T

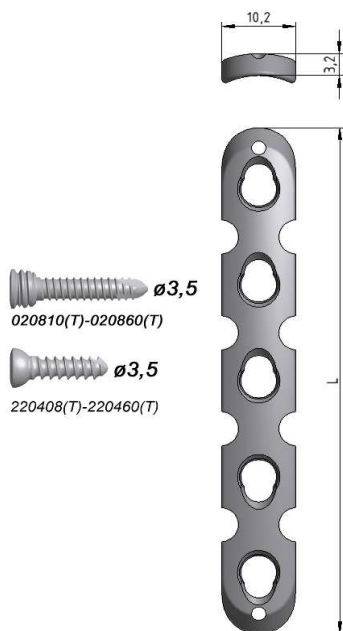
**3,5 SYSTEM***Mikromed Locking Plates***Płytki blokowane rekonstrukcyjna 10,2x3,2**  
Reconstruction locking plate 10,2x3,2

Otwory Holes	L [mm]	Nr katalogowy Cat No	
		SS	
6	88	012256	
7	102	012257	
8	116	012258	
9	130	012259	
10	144	012260	

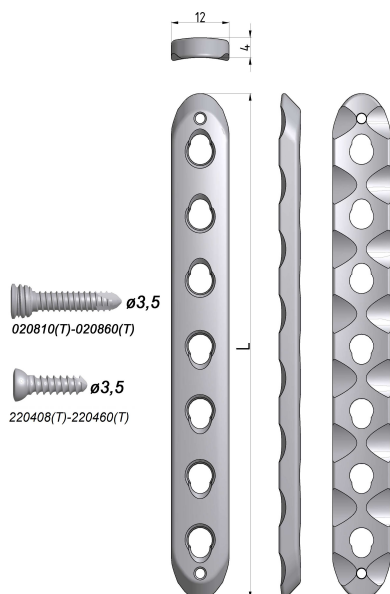
**3,5 SYSTEM***Mikromed Locking Plates***Płytki blokowane wąska 12x4,0**  
Narrow locking plate 12x4,0

Otwory Holes	L [mm]	Nr katalogowy Cat No	
		SS	Ti
6	87	012106	012106T
7	102	012107	012107T
8	115	012108	012108T
9	128	012109	012109T
10	141	012110	012110T
11	154	012111	012111T
12	167	012112	012112T

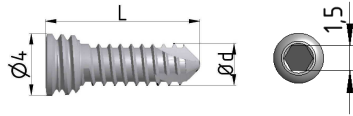

**Wkręt blokujący Ø2,4 i Ø2,7**  
**Locking screw Ø2,4 and Ø2,7**

L [mm]	Nr katalogowy/ Cat No	
	Ød=2,4mm	Ød=2,7mm
6	021706	021306
8	021708	021308
10	021710	021310
12	021712	021312
14	021714	021314
15	021715	021315
16	021716	021316
18	021718	021318
20	021720	021320
22	021722	021322
24	021724	021324
25	021725	021325
26	021726	021326
28	021728	021328
30	021730	021330
32	021732	021332
34	021734	021334
35	021735	021335
36	021736	021336
38	021738	021338
40	021740	021340

**3,5 SYSTEM**  
Mikromed Locking Plates

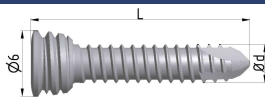

Wkręt blokujący Ø2,7; Ø3,5 i Ø4,0  
Locking screw Ø2,7; Ø3,5 and Ø4,0

L [mm]	Nr katalogowy/ Cat No		
	Ød=2,7mm	Ød=3,5mm	Ød=4,0mm
10	021510	020810	021911
12	021512	020812	021912
14	021514	020814	021914
15	021515	020815	021915
16	021516	020816	021916
18	021518	020818	021918
20	021520	020820	021920
22	021522	020822	021922
24	021524	020824	021924
25	021525	020825	021925
26	021526	020826	021926
28	021528	020828	021928
30	021530	020830	021930
32	021532	020832	021932
34	021534	020834	021934
35	021535	020835	021935
36	021536	020836	021936
38	021538	020838	021938
40	021540	020840	021940
42	-	020842	021942
44	-	020844	021944
45	-	020845	021945
46	-	020846	021946
48	-	020848	021948
50	-	020850	021950
52	-	020852	021952
54	-	020854	021954
55	-	020855	021955
56	-	020856	021956
58	-	020858	021958
60	-	020860	021960

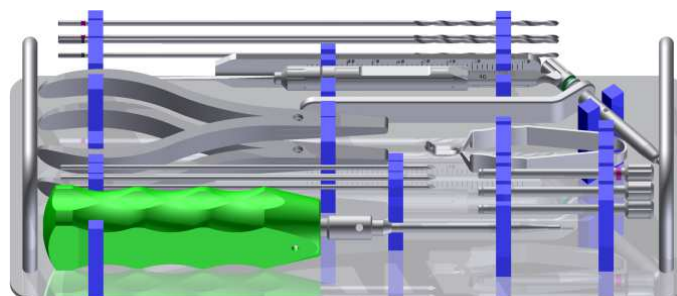
**871021 – ZESTAW INSTRUMENTÓW SYSTEM 2,4**  
**871021 – SET OF INSTRUMENTS 2,4 SYSTEM**

Lp.	Nazwa elementu/ Description	Nr katalogowy Cat No	Ilość Quantity
1	Prowadnik wiertła Ø2,0mm dla wkrętów blokujących Ø2,4 SYSTEM 2,4 Drill guide Ø2,0mm for locking screw Ø2,4mm SYSTEM 2,4	075055	2
2	Prowadnik wiertła Ø2,2mm dla wkrętów blokujących Ø2,7 SYSTEM 2,4 Drill guide Ø2,2mm for locking screw Ø2,7mm SYSTEM 2,4	075056	2
3	Prowadnica kompresyjna Ø2,0mm Compression guide Ø2,0mm	750014	1
4	Wiertło Ø2,0x200mm Drill Ø2,0x200mm	712120	2
5	Wiertło Ø2,2x200mm Drill Ø2,2x200mm	712122	2
6	Miarka długości wkrętów Length gauge for locking screw	770110	1
7	Miarka głębokości Depth gauge	771020	1
8	Wkrętak dynamometryczny S1,5, 0,8Nm Torque limiting screwdriver S1,5 0,8Nm	783115	1
9	Drut Kirschnera Ø1,0/M1; L-150/5mm Kirschner wire Ø1,0/M1; L-150/5mm	311000	2
10	Drut Kirschnera Ø1,0mm; L-150mm Kirschner wire Ø1,0mm; L-150mm	311015	2
11	Wyginak płytek drobnych Bending pilers for small bones	470020	2
12	Szczypce Forceps	470001	1
13	Paleta Tray	540021	1
<b>Elementy dodatkowe / Additional elements</b>			
14	Kaseta sterylizacyjna Sterilisation container	540016	opcjonalnie optional
15	Paleta na wkręty SYSTEM 2,4 Tray for screws SYSTEM 2,4	540026	opcjonalnie optional

**3,5 SYSTEM**  
Mikromed Locking Plates

**871022 – ZESTAW INSTRUMENTÓW SYSTEM 3,5**  
**871022 – SET OF INSTRUMENTS 3,5 SYSTEM**

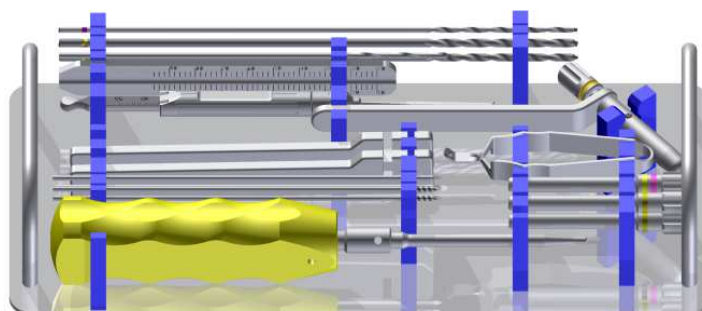

Lp.	Nazwa elementu / Description	Nr katalogowy Cat No	Ilość Quantity
1	Prowadnik wiertła Ø2,2mm dla wkrętów blokujących Ø2,7mm SYSTEM 3,5 Drill guide Ø2,2mm for locking screw Ø2,7mm SYSTEM 3,5	075057	2
2	Prowadnik wiertła Ø3,0mm dla wkrętów blokujących Ø3,5mm SYSTEM 3,5 Drill guide Ø3,0mm for locking screw Ø3,5mm SYSTEM 3,5	075060	2
3	Prowadnica kompresyjna Ø2,5mm Compression guide Ø2,5mm	750015	1
4	Wiertło Ø2,2x200mm Drill Ø2,2x200mm	712122	2
5	Wiertło Ø3,0x200mm Drill Ø3,0x200mm	712130	2
6	Wiertło Ø2,5x150mm Drill Ø2,5x150mm	711025	1
7	Miarka długości wkrętów Length gauge for screw	770110	1
8	Miarka głębokości Depth gauge	771020	1
9	Wkrętak dynamometryczny S2,5, 1,5Nm Torque limiting screwdriver S2,5 1,5Nm	783125	1
10	Drut Kirschnera Ø2,0/M2; L-150/15mm Kirschner wire Ø2,0/M2; L-150/15mm	312001	2
11	Drut Kirschnera Ø2,0; L-150mm Kirschner wire Ø2,0; L-150mm	312015	2
12	Wyginak płytek 2,7/3,5mm Bending iron for plates 2,7/3,5mm	790534	2
13	Szczypce Forceps	470001	1
14	Paleta Tray	540022	1
<b>Elementy dodatkowe / Additional elements</b>			
15	Kaseta sterylizacyjna Sterilisation container	540016	opcjonalnie optional
16	Paleta na wkręty SYSTEM 3,5 Tray for screws SYSTEM 3,5	540028	opcjonalnie optional



Prowadnik wiertła dla wkrętów blokowanych  
Drill guide for locking screw

Prowadnik wiertła Drill guide	SYSTEM	Dla wkrętów For screws	Wiertło Drill	Nr katalogowy Cat No
	2,4 SYSTEM Mikromed Locking Plates	Ø2,4	Ø 2,0	075055
		Ø2,7	Ø 2,2	075056
	3,5 SYSTEM Mikromed Locking Plates	Ø2,7	Ø 2,2	075057
		Ø3,5	Ø 3,0	075060

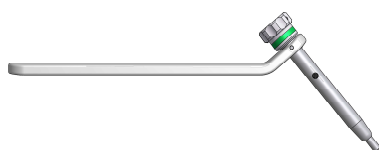

Prowadnica kompresyjna  
Compression guide

SYSTEM	Dla wkrętów standardowych For standard screws	Wiertło Drill	Nr katalogowy Cat No
2,4 SYSTEM Mikromed Locking Plates	Ø2,7	Ø 2,0	750014
3,5 SYSTEM Mikromed Locking Plates	Ø3,5	Ø2,5	750015



Wiertło dla wkrętów blokowanych  
Drill for locking screws

ØD[mm]	Kolor Colour	Dla wkrętów For screws	Nr katalogowy Cat No
Ø2,0	zielony green	2,4 SYSTEM Mikromed Locking Plates	712120
Ø2,2	magenta	2,4 SYSTEM Mikromed Locking Plates 3,5 SYSTEM Mikromed Locking Plates	712122
Ø3,0	żółty yellow	3,5 SYSTEM Mikromed Locking Plates	712130



Wiertło dla wkrętów standardowych  
Drill for standard screws

ØD[mm]	Dla wkrętów standardowych For standard screws	Nr katalogowy Cat No
Ø2,5	Ø3,5	711025

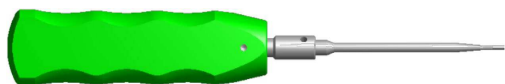

**Wkrętak dynamometryczny**  
Torque Limiting Screwdriver

Dla wkrętów For screws	S	F [Nm]	Nr katalogowy Cat No
<b>2,4 SYSTEM</b> Mikromed Locking Plates	1,5	0,7	783115
<b>3,5 SYSTEM</b> Mikromed Locking Plates	2,5	1,5	783125

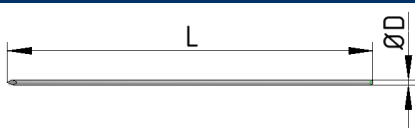

**Drut Kirschnera**  
Kirschner wire

SYSTEM	ØD[mm]	L [mm]	Nr katalogowy Cat No
<b>2,4 SYSTEM</b> Mikromed Locking Plates	Ø1,0/M1	150	311000
	Ø1,0	150	311015
<b>3,5 SYSTEM</b> Mikromed Locking Plates	Ø2,0/M2	150	312001
	Ø2,0	150	312015



**Miarka głębokości**  
Depth gauge

SYSTEM	Zakres pomiarowy Measuring range	Nr katalogowy Cat No
<b>2,4 SYSTEM</b> Mikromed Locking Plates	0 – 50	771020
<b>3,5 SYSTEM</b> Mikromed Locking Plates		



**Wyginak płytek 2,7/3,5mm**  
Bending iron for plates 2,7/3,5mm

Nr katalogowy/ Cat No

790534



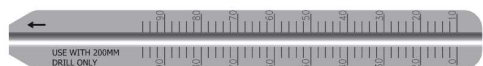

Miarka długości wkrętów blokujących  
Length gauge for locking screw

Nr katalogowy/ Cat No

770110

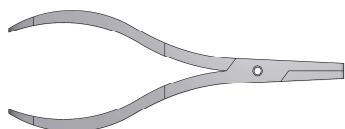

Wyginak do płytek drobnych  
Bending pliers for small plates

Nr katalogowy/ Cat No

470020



Pinceta do wkrętów drobnych  
Forceps

Nr katalogowy/ Cat No

470001

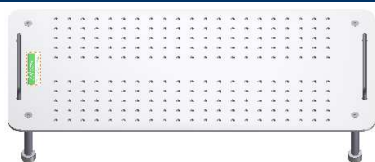

Paleta na wkręty  
Tray for screws

SYSTEM	Kaseta sterylizacyjna/ Sterilization container	Nr katalogowy/ Cat No
<b>2,4 SYSTEM</b> <i>Mikromed Locking Plates</i>	540015	540026
<b>3,5 SYSTEM</b> <i>Mikromed Locking Plates</i>	540015	540028

Palety sterylizacyjne do zestawu instrumentarium (bez narzędzi)  
Sterilization trays for set of instruments (without instruments)

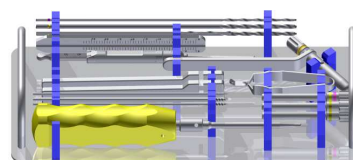
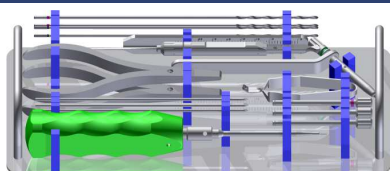

SYSTEM	Kaseta sterylizacyjna/ Sterilization container	Nr katalogowy/ Cat No
<b>2,4 SYSTEM</b> <i>Mikromed Locking Plates</i>	540016	540021
<b>3,5 SYSTEM</b> <i>Mikromed Locking Plates</i>	540016	540022

## PŁYTKI PROSTE / STRAIGHT PLATES

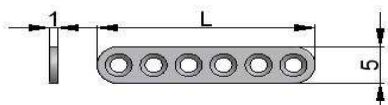

**Płytką drobna 5,0x1,0mm pod wkręty  $\varnothing$ 1,5mm**  
Small plate 5,0x1,0mm for screws  $\varnothing$ 1,5mm

Otwory/ Holes	L [mm]	Nr katalogowy/ Cat No
2	9	111102
3	13	111103
4	17	111104
5	21	111105
6	25	111106
7	29	111107
8	33	111108
9	37	111109
10	41	111110

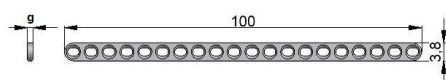

**Płytką drobna 3,8 20 otworów pod wkręty  $\varnothing$ 1,5mm**  
Small plate 3,8 20 holes for screws  $\varnothing$ 1,5mm

g [mm]	Nr katalogowy/ Cat No
1,0	111150
1,5	111151

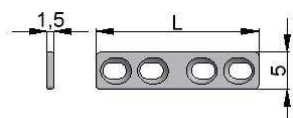

**Płytką drobna samodociskowa 5,0x1,5mm dla wkrętów  $\varnothing$ 2,0mm**  
Small plate self-compressing 5,0 x 1,5mm for screws  $\varnothing$ 2,0mm

Otwory/ Holes	L[mm]	Nr katalogowy/ Cat No
2	17	122102
3	22	122103
4	27	122104
5	32	122105
6	37	122106
7	42	122107
8	47	122108
9	52	122109
10	57	122110
12	67	122112
14	77	122114
16	87	122116

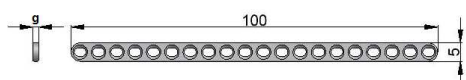

**Płytką drobna 5,0 20 otworów pod wkręty  $\varnothing$ 2,0mm**  
 Small plate 5,0 20 holes for screws  $\varnothing$ 2,0mm

g [mm]	Nr katalogowy/ Cat No
1,5	111200
2,0	111201

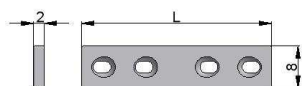

**Płytką drobna 8,0x2,0mm samodociskowa pod wkręty  $\varnothing$ 2,0mm**  
 Small plate 8,0x2,0mm self-compressing for screws  $\varnothing$ 2,0mm

Otwory/ Holes	L [mm]	Nr katalogowy/ Cat No
2	20	122202
4	36	122204
6	52	122206
8	68	122208
10	84	122210
12	100	122212
14	116	122214
16	132	122216

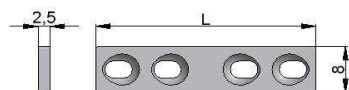

**Płytką drobną 8,0 x 2,5mm samodociskowa pod wkręty  $\varnothing$ 2,7mm**  
 Small plate 8,0 x 2,5mm self-compressing for screws  $\varnothing$  2,7mm

Otwory/ Holes	L [mm]	Nr katalogowy/ Cat No
7	60	123207
8	68	123208
9	76	123209
10	84	123210
12	100	123212

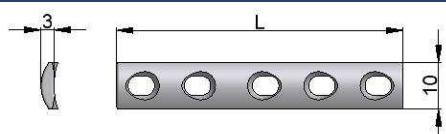

**Płytką drobną 10,0x3,0mm samodociskowa z otworami kulistymi pod wkręty  $\varnothing$ 3,5mm i  $\varnothing$ 4,0mm**  
 Small plate 10,0x3,0mm self-compressing with round holes for screws  $\varnothing$ 3,5mm and  $\varnothing$ 4,0mm

Otwory/ Holes	L [mm]	Nr katalogowy/ Cat No
2	26	125402
3	38	125403
4	50	125404
5	62	125405
6	74	125406
7	86	125407
8	98	125408
10	122	125410
12	146	125412

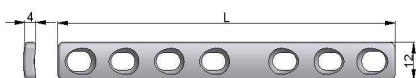

**Płytką wąską samodociskowa 12,0x4,0mm z otworami kulistymi z ograniczonym kontaktem pod wkręty  $\varnothing$ 4,5mm**  
 Narrow plate self-compressing 12,0x4,0mm limited contact with round holes for screws  $\varnothing$ 4,5mm

Otwory/ Holes	L [mm]	Nr katalogowy/Cat No
2	39	120302
3	55	120303
4	71	120304
5	87	120305
6	103	120306
7	119	120307
8	135	120308
9	151	120309
10	167	120310

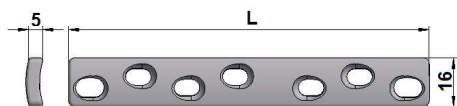

**Płytką szeroka samodociskowa 16,0x5,0mm z otworami kulistymi z ograniczonym kontaktem pod wkręty  $\varnothing$ 4,5mm**  
Wide plate self-compressing 16,0x5,0mm limited contact and round holes for screws  $\varnothing$ 4,5mm

Otwory/ Holes	L [mm]	Nr katalogowy/ Cat No
4	71	121304
5	87	121305
6	103	121306
7	119	121307
8	135	121308
9	151	121309
10	167	121310

## PŁYTKI KSZTAŁTOWE / SHAPED PLATES

HOLES DESCRIPTION		
A		<b>Otwór stożkowy przesuwany</b> Conical sliding hole
C		<b>Otwór stożkowy samodociskowy 45°</b> Conical hole self-compressing 45 degrees
D		<b>Otwór stożkowy samodociskowy 27°</b> Conical hole self-compressing 27 degrees
R		<b>Otwór stożkowy</b> Conical hole

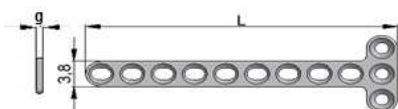

**Płytką T – 3,8 pod wkręty Ø1,5mm**  
T plate – 3,8 for screws Ø1,5mm

	Otwory Holes	L [mm]	g [mm]	Nr katalogowy/ Cat No
	3/9	49	1,0	198193
	4/9			198194
	2/9			198195
	2/8	44	1,5	198196
			1,0	198197
			1,5	198199

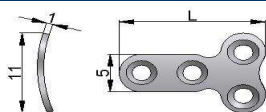

**Płytką T – mini pod wkręty Ø1,5mm**  
T plate – mini for screws Ø1,5mm

	Otwory/ Holes	L [mm]	Nr katalogowy/ Cat No
	2/1	11	197153
	2/2	17	197154
	2/3	23	197155
	2/4	29	197156
	2/5	35	197177
	2/6	41	197178
	2/7	47	197179
	2/8	53	197180

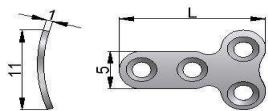

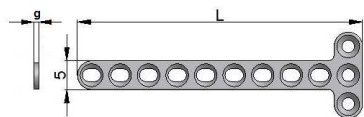

**Płytki T – mini pod wkręty Ø2,0mm**  
T plate – mini for screws Ø2,0mm

	Otwory/ Holes	L [mm]	Nr katalogowy/ Cat No
	2/1	11	197149
	2/2	17	197150
	2/3	23	197151
	2/4	29	197152
	2/5	35	197167
	2/6	41	197168
	2/7	47	197169
	2/8	53	197170

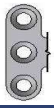

**Płytki T – 5,0 pod wkręty Ø2,0mm**  
T plate – 5,0 for screws Ø2,0mm

	Otwory/ Holes	L [mm]	g [mm]	Nr katalogowy/ Cat No
	3/9	50	1,2	198093
	4/9			198094
	2/9	45	1,5	198095
	2/9		2,0	198096
	2/8		1,5	198097
	2/8		2,0	198099

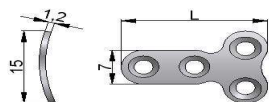

**Płytki T – mini pod wkręty Ø2,7mm**  
T plate – mini for screws Ø2,7mm

	Otwory/ Holes	L [mm]	Nr katalogowy/ Cat No
	2/1	15	197138
	2/2	23	197139
	2/3	31	197140
	2/4	39	197141

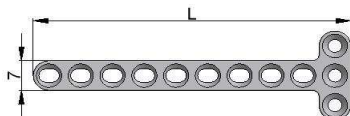

Płytką T – 7,0x1,5mm pod wkręty Ø2,7mm  
T plate – 7,0x1,5mm for screws Ø2,7mm

	Otworki/ Holes	L [mm]	Nr katalogowy/ Cat No
	3/9	80	198293
	4/9		198294

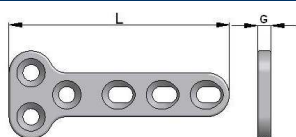

Płytką T pod wkręty Ø2,7mm, Ø3,5mm i Ø4,5mm  
T plate for screws Ø2,7mm, Ø3,5mm and Ø4,5mm

L [mm]	G [mm]	Otworki/ Holes	Nr katalogowy/ Cat No		
			Wkręty/ Screws Ø2,7mm	Wkręty/ Screws Ø3,5mm	Wkręty/ Screws Ø 4,5mm
40	2,5	3/3	012540	-	-
55		3/3	-	012554	-
76		3/4	-	012576	-
90	4,5	3/4	-	-	012590
55	3,5	3/3	-	013554	-
76		3/4	-	013576	-

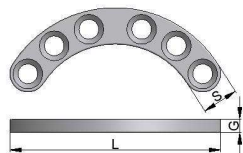

Płytką do miednicy pod wkręty Ø2,0 - 3,5mm  
Plate for pelvis for screws Ø2,0 – 3,5mm

L [mm]	Wymiar/ Dimension S x G [mm]	Otworki/ Holes	Nr katalogowy/ Cat No		
			Wkręty/ Screws Ø2,0mm	Wkręty/ Screws Ø2,7mm	Wkręty/ Screws Ø3,5mm
18	3,5 x 1,5	4	010435		
32	5,5 x 2,0	6		010455	
35	6,0 x 2,0	6		010460	
41	6,5 x 2,5	6			010465
45	8,0 x 2,5	6			010480



## PŁYTKI REKONSTRUKCYJNE / RECONSTRUCTION PLATES

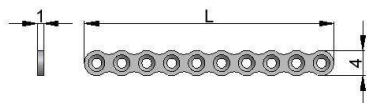

**Płytki rekonstrukcyjna 4,0x1,0mm mikro pod wkręty Ø1,5mm**  
 Reconstruction plate 4,0x1,0mm micro for screws Ø1,5mm

Otwory /Holes	L [mm]	Nr katalogowy/ Cat No
4	16	010062
6	24	010064
8	32	010066
10	40	010068
12	48	010070



**Płytki rekonstrukcyjna 5,0x1,0mm pod wkręty Ø2,0mm**  
 Reconstruction plate 5,0x1,0mm for screws Ø2,0mm

Otwory/ Holes	L [mm]	Nr katalogowy/ Cat No
6	31	010026
7	36	010027
8	41	010028
10	51	010030
12	61	010032
14	71	010034
16	81	010036



**Płytki rekonstrukcyjna 8,0x2,0mm pod wkręty Ø2,7mm**  
 Reconstruction plate 8,0x2,0mm for screws Ø2,7mm

Otwory/ Holes	L [mm]	Nr katalogowy/ Cat No
4	32	010094
5	40	010095
6	48	010096
8	64	010098
10	80	010100

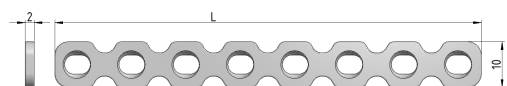

**Płytką rekonstrukcyjną 10,0x2,0mm**  
**pod wkręty Ø3,5mm i Ø4,0mm**  
 Reconstruction plate 10,0x2,0mm  
 for screws Ø3,5mm and Ø4,0mm

Otwory/ Holes	L [mm]	Nr katalogowy/ Cat No
4	46	010042
5	58	010043
6	70	010044
8	94	010046
10	118	010048

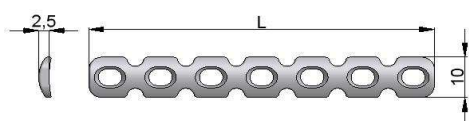

**Płytką rekonstrukcyjną 10,0x2,5mm prosta**  
**pod wkręty Ø3,5mm i Ø4,0mm**  
 Reconstruction plate 10,0x2,5mm straight  
 for screws Ø3,5mm and Ø4,0mm

Otwory/ Holes	L [mm]	Nr katalogowy/ Cat No
5	58	010005
6	70	010006
7	82	010007
8	94	010008
9	106	010009
10	118	010010

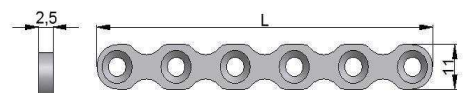

**Płytką rekonstrukcyjną cienką**  
**pod wkręty Ø3,5mm i Ø4,0mm**  
 Reconstruction thin plate  
 for screws Ø3,5mm and Ø4,0mm

Otwory/ Holes	L [mm]	Nr katalogowy/ Cat No
6	91	166006
7	107	166007
8	123	166008
9	139	166009
10	155	166010

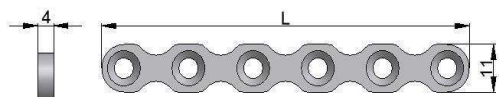

**Płytką rekonstrukcyjną pod wkręty Ø4,5mm**  
 Reconstruction plate for screws Ø4,5mm

Otwory/ Holes	L [mm]	Nr katalogowy/ Cat No
6	91	160106
7	107	160107
8	123	160108
10	155	160110

WKRETY / SCREWS

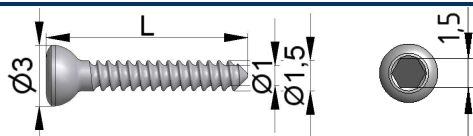

Wkręt do kości drobnych Ø1,5/1,0mm  
Screw for small bones Ø1,5/1,0mm

L [mm]	Nr katalogowy/ Cat No	
6		223106
7		223107
8		223108
9		223109
10		223110
11		223111

L [mm]	Nr katalogowy/ Cat No	
12		223112
13		223113
14		223114
15		223115
16		223116

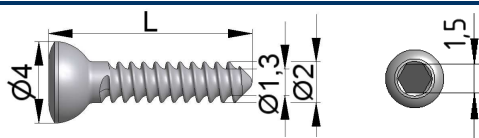

Wkręt do kości drobnych Ø2,0/1,3mm  
Screw for small bones Ø2,0/1,3mm

L [mm]	Nr katalogowy/ Cat No	
5		222305
6		222306
7		222307
8		222308
9		222309
10		222310
11		222311
12		222312
13		222313
14		222314
15		222315

L [mm]	Nr katalogowy/ Cat No	
16		222316
17		222317
18		222318
19		222319
20		222320
21		222321
22		222322
23		222323
24		222324
25		222325

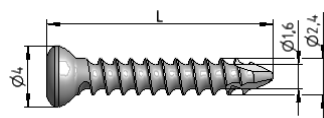



Wkręt Ø2,4/1,6mm pełnogwintowany, samogwintujący  
Screw Ø2,4/1,6mm, fully threaded, self-tapping

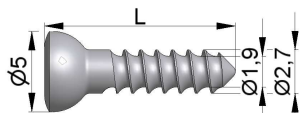

L [mm]	Nr katalogowy/ Cat No
10	023010
12	023012
14	023014
15	023015
16	023016
18	023018
20	023020
22	023022
24	023024
25	023025

L [mm]	Nr katalogowy/ Cat No
26	023026
28	023028
30	023030
32	023032
34	023034
35	023035
36	023036
38	023038
40	023040





Wkręt do kości drobnych  $\varnothing 2,7/1,9\text{mm}$   
Screw for small bones  $\varnothing 2,7/1,9\text{mm}$

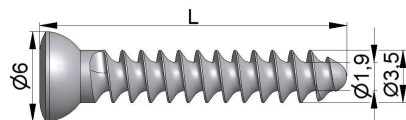

L [mm]	Nr katalogowy/ Cat No	
		
6	221206	221306
7	221207	221307
8	221208	221308
9	221209	221309
10	221210	221310
11	221211	221311
12	221212	221312
13	221213	221313
14	221214	221314
15	221215	221315
16	221216	221316
17	221217	221317
18	221218	221318
19	221219	221319
20	221220	221320

L [mm]	Nr katalogowy/ Cat No	
		
21	221221	221321
22	221222	221322
23	221223	221323
24	221224	221324
25	221225	221325
26	221226	221326
28	221228	221328
30	221230	221330
32	221232	221332
34	221234	221334
35	221235	221335
36	221236	221336
38	221238	221338
40	221240	221340

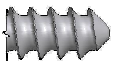



Wkręt do kości drobnych  $\varnothing 3,5/1,9\text{mm}$   
Screw for small bones  $\varnothing 3,5/1,9\text{mm}$

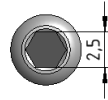
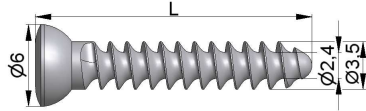

L [mm]	Nr katalogowy/ Cat No	
		
8	220208	220408
10	220210	220410
12	220212	220412
14	220214	220414
15	220215	220415
16	220216	220416
18	220218	220418
20	220220	220420
22	220222	220422
24	220224	220424
25	220225	220425
26	220226	220426
28	220228	220428
30	220230	220430
32	220232	220432
34	220234	220434

L [mm]	Nr katalogowy/ Cat No	
		
35	220235	220435
36	220236	220436
38	220238	220438
40	220240	220440
42	220242	220442
44	220244	220444
45	220245	220445
46	220246	220446
48	220248	220448
50	220250	220450
52	220252	220452
54	220254	220454
55	220255	220455
56	220256	220456
58	220258	220458
60	220260	220460



Wkręt do kości drobnych  $\varnothing 3,5/2,4\text{mm}$   
Screw for small bones  $\varnothing 3,5/2,4\text{mm}$

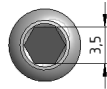
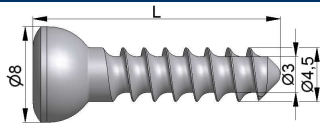

L [mm]	Nr katalogowy/ Cat No	
		
14	220514	220714
15	220515	220715
16	220516	220716
18	220518	220718
20	220520	220720
22	220522	220722
24	220524	220724
25	220525	220725
26	220526	220726
28	220528	220728
30	220530	220730
32	220532	220732
34	220534	220734

L [mm]	Nr katalogowy/ Cat No	
		
35	220535	220735
36	220536	220736
38	220538	220738
40	220540	220740
42	220542	220742
44	220544	220744
45	220545	220745
46	220546	220746
48	220548	220748
50	220550	220750
55	220555	220755
60	220560	220760



Wkręt do kości korowej  $\varnothing 4,5/3,0\text{mm}$   
Cortex screw  $\varnothing 4,5/3,0\text{mm}$

L [mm]	Nr katalogowy/ Cat No	
		
12	200212	200512
14	200214	200514
16	200216	200516
18	200218	200518
20	200220	200520
22	200222	200522
24	200224	200524
26	200226	200526
28	200228	200528
30	200230	200530
32	200232	200532
34	200234	200534
36	200236	200536

L [mm]	Nr katalogowy/ Cat No	
		
38	200238	200538
40	200240	200540
42	200242	200542
44	200244	200544
46	200246	200546
48	200248	200548
50	200250	200550
52	200252	200552
54	200254	200554
56	200256	200556
58	200258	200558
60	200260	200560

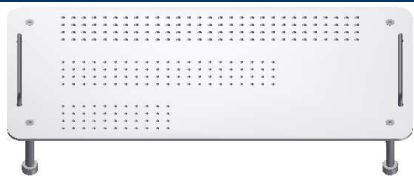

**Paleta na wkręty**  
Tray for screws

Na wkręty/ For screws	Kaseta sterylizacyjna/ Sterilization container	Nr katalogowy/ Cat No
Ø1,5; Ø2,0	540015	540024
Ø1,5; Ø2,0; Ø2,7	540015	540036
Ø3,5; Ø4,5	540015	540038

PODKŁADKI/ WASHERS

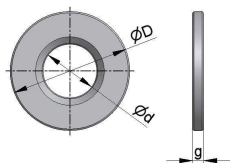

Podkładka pod wkręty  
Washer for screws

Grubość [mm] Thickness [mm]	D [mm]	d [mm]	Ø wkręta Ø of screw	Nr katalogowy/ Cat No
1	7	2,8	2,0; 2,7	292004
	7	4,2	3,5; 4,0	292005
11	292007			
1,5	11	5	4,5	292010
	13			292015
	16			292016
	16	6,7	6,5	292018
	19	5	4,5	292020
	11	6,7	6,5	292210
	13			292215
	13	7,2	7,0 kaniulowane cannulated	292113
	16			292115
	19			292120

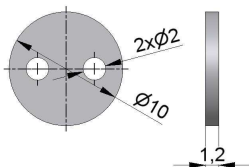

Podkładka 2-otworowa  
2-holes washer

Nr katalogowy/ Cat No

292110

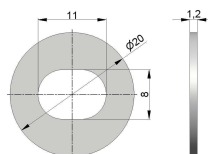

Podkładka z otworem owalnym  
Washer with oval hole

Nr katalogowy/ Cat No

292220

## DRUTY/ WIRES



Drut do wiązania odłamów kostnych  
Cerclage wire

L [m]	ØD [mm]	Nr katalogowy Cat No
		SS
5	0,2	300205
	0,3	300305
	0,4	300405
	0,5	300505
	0,6	300605
	0,7	300705
	0,8	300805
	0,9	300905
	1,0	301005
	1,2	301205
	1,5	301505
	1,8	301805
	2,0	302005



Blokada cerklarzu do otworów samodociskowych  
pod wkręty Ø3,5 mm i Ø4,0 mm  
Cerclage button for self-compressing holes  
for screws Ø3,5 mm and Ø4,0 mm

A [mm]	Nr katalogowy/ Cat No
2,5	022025
3,0	022030
4,0	022040



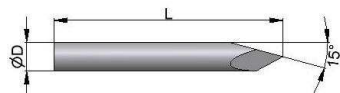

**Drut Kirschnera z ostrzem jednostronnym typu trokar**  
Kirschner wire with trocar tip

ØD [mm]	Nr katalogowy/ Cat No			
	SS			
	L [mm]			
	150	210	310	400
1,0	311015	311021	311031	–
1,1	311115	311121	311131	–
1,2	311215	311221	311231	–
1,4	311415	311421	311431	–
1,5	311515	311521	311531	–
1,6	311615	311621	311631	–
1,8	311815	311821	311831	–
2,0	312015	312021	312031	312040
2,2	312215	312221	312231	312240
2,4	312415	312421	312431	312440
2,5	312515	312521	312531	312540
3,0	–	–	313031	313040
3,5	313515	313521	313531	313540

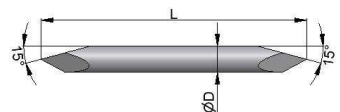

**Drut Kirschnera z ostrzem obustronnym typu trokar**  
Kirschner wire with double trocar tip

ØD [mm]	Nr katalogowy/ Cat No			
	SS			
	L [mm]			
	150	210	310	400
1,0	311015D	311021D	311031D	–
1,1	311115D	311121D	311131D	–
1,2	311215D	311221D	311231D	–
1,4	311415D	311421D	311431D	–
1,5	311515D	311521D	311531D	–
1,6	311615D	311621D	311631D	–
1,8	311815D	311821D	311831D	–
2,0	312015D	312021D	312031D	312040D
2,2	312215D	312221D	312231D	312240D
2,4	312415D	312421D	312431D	312440D
2,5	312515D	312521D	312531D	312540D
3,0	–	–	313031D	313040D
3,5	313515D	313521D	313531D	313540D

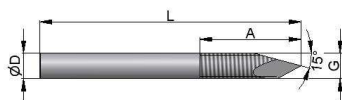

**Drut Kirschnera z ostrzem gwintowanym typu trokar**  
Kirschner wire with threaded tip

A [mm]	G	ØD [mm]	Nr katalogowy/ Cat No			
			SS			
			L [mm]			
			150	200	250	310
5	M1	1,0	311000	311003	311004	311006
	M1,2	1,2	311201	311204	311205	311200
	M1,5	1,5	311501	311504	311505	311507
15	M1,6	1,6	311601	311604	311605	311607
	M1,8	1,8	311801	311804	311805	311807
	M2,0	2,0	312001	312004	312005	312000
	M2,5	2,5	312501	312504	312505	312507
	M3,0	3,0	313001	313004	313005	313007

## GROTOWKRĘTY / PINS

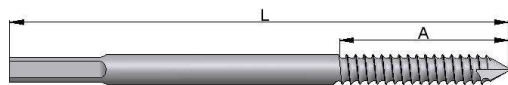

Grotowkręt Schanza samogwintujący  
Schanz screw self-tapping

L [mm]	Nr katalogowy/ Cat No					
	SS					
	A = 25mm		A = 36mm			
	ØD = 2,5mm	ØD = 3,0mm	ØD = 4,0mm	ØD = 4,5mm	ØD = 5,0mm	ØD = 6,0mm
S = 2,0mm	S = 2,4mm	S = 3,2mm	S = 3,6mm	S = 4,0mm	S = 4,8mm	
60	362506	363006	364006	364506	365006	366006
70	362507	363007	364007	364507	365007	366007
80	362508	363008	364008	364508	365008	366008
90	362509	363009	364009	364509	365009	366009
100	362510	363010	364010	364510	365010	366010
110	362511	363011	364011	364511	365011	366011
120	362512	363012	364012	364512	365012	366012
130	362513	363013	364013	364513	365013	366013
140	362514	363014	364014	364514	365014	366014
150	362515	363015	364015	364515	365015	366015
160	362516	363016	364016	364516	365016	366016
170	362517	363017	364017	364517	365017	366017
180	362518	363018	364018	364518	365018	366018
190	362519	363019	364019	364519	365019	366019
200	362520	363020	364020	364520	365020	366020
210	362521	363021	364021	364521	365021	366021
220	362522	363022	364022	364522	365022	366022
250	362525	363025	364025	364525	365025	366025
280	362528	363028	364028	364528	365028	366028
300	362530	363030	364030	364530	365030	366030
320	362532	363032	364032	364532	365032	366032

## SYSTEM ZESPOL

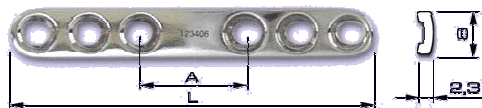

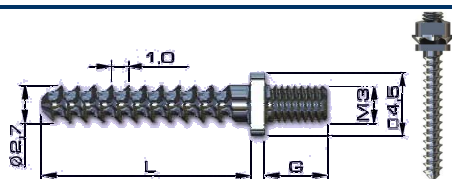

Płytkę samodosciskowa wąska ZESPOL MIKRO  
ZESPOL MIKRO narrow plate self-compressing

Otworki/ Holes	A [mm]	L [mm]	Nr katalogowy/ Cat No
2	8	16	123402
2	16	24	123502
4	8	32	123404
4	16	40	123504
6	16	56	123406
6	32	72	123506



Wkręt do kości drobnych ZESPOL MIKRO Ø2,7mm z nakrętką  
ZESPOL MIKRO screw for small bones Ø2,7mm with nut

L [mm]	Nr katalogowy/ Cat No	
		
	G=4,5mm	
8	221408	231408
10	221410	231410
12	221412	231412
14	221414	231414
16	221416	231416
18	221418	231418
20	221420	231420
22	221422	231422
24	221424	231424



Nakrętka do wkrętów ZESPOL MIKRO  
Nut for ZESPOL MIKRO screws

G [mm]	S [mm]	Nr katalogowy/ Cat No
		SS
M3	4,5	290430



Płytkę ZESPOL MINI samodociskowa 11x4mm  
ZESPOL MINI plate self-compression 11x4 mm

Otworki/ Holes	A [mm]	L [mm]	Nr katalogowy/ Cat No
4	32	78	122404
4	48	94	122504
5	32	94	122405
5	48	110	122505
6	32	110	122406
6	48	126	122506
6	64	142	122606

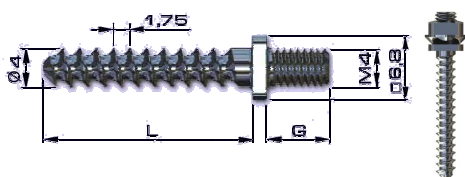

Wkręt do kości korowej ZESPOL MINI Ø4,0mm z nakrętką  
ZESPOL MINI cortex screw Ø4,0mm with nut

L [mm]	Nr katalogowy/ Cat No	
	G=6,5mm	
16	241416	251416
18	241418	251418
20	241420	251420
22	241422	251422
24	241424	251424
26	241426	251426
28	241428	251428
30	241430	251430
32	241432	251432
34	241434	251434
36	241436	251436
38	241438	251438
40	241440	251440

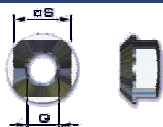

Nakrętka do wkrętów ZESPOL MINI  
Nut for ZESPOL MINI screws

G [mm]	S [mm]	Nr katalogowy/ Cat No
		SS
M4	6,8	290440

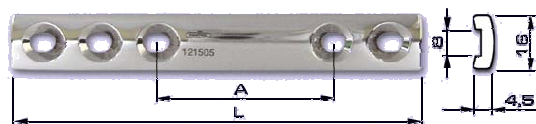

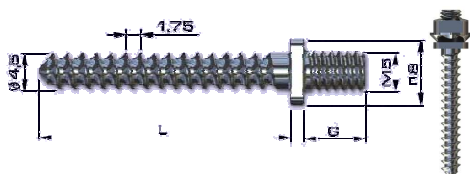

Płytką ZESPOL STANDARD samodociskowa  
ZESPOL STANDARD plate self-compression

Otworki/ Holes	A [mm]	L [mm]	Nr katalogowy/ Cat No
4	32	82	121404
4	48	98	121504
6	32	114	121406
6	48	130	121506
6	64	146	121606
8	32	146	121408



Wkręt do kości korowej ZESPOL STANDARD  $\varnothing$ 4,5mm z nakrętką  
ZESPOL STANDARD cortex screw  $\varnothing$ 4,5mm with nut

L [mm]	Nr katalogowy/ Cat No	
		
	G=7,5mm	
26	200426	210426
28	200428	210428
30	200430	210430
32	200432	210432
34	200434	210434
36	200436	210436
38	200438	210438
40	200440	210440
42	200442	210442
44	200444	210444

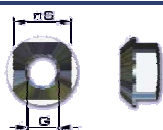

Nakrętka do wkrętów ZESPOL STANDARD  
Nut for ZESPOL STANDARD screws

G [mm]	S [mm]	Nr katalogowy/ Cat No
		SS
M5	8,0	290450

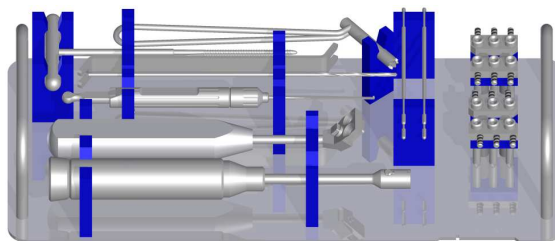
ZESTAW INSTRUMENTÓW ZESPOL MIKRO  
 ZESPOL MICRO – SET OF INSTRUMENTS

Lp.	Nazwa elementu / Description	Nr katalogowy Catalog. No.	Ilość Quantity
1	Uchwyt prowadniczy kostkowej ZESPOL MIKRO Guide holder ZESPOL MIKRO	750029	1
2	Kostka 3-otworowa „0” ZESPOL MIKRO ZESPOL blocks MIKRO 3 holes compressing „0”	750024	2
3	Kostka 3-otworowa „0,8” ZESPOL MIKRO ZESPOL blocks MIKRO 3 holes compressing „0,8”	750025	1
4	Kostka 3-otworowa „1,6” ZESPOL MIKRO ZESPOL blocks MIKRO 3 holes compressing „1,6”	750026	1
5	Pręt ustalający Ø2,0mm ZESPOL Seating rod Ø2,0mm	750028	6
6	Miarka głębokości L=50mm Depth gauge L=50mm	771020	1
7	Wiertło Ø2,0mm Drill Ø2,0mm	711020	1
8	Gwintownik Ø2,7x1,0mm Tap Ø2,7x1,0mm	720027	1
9	Ośłona gwintownika Ø2,7mm Tap sleeve Ø2,7mm	730027	1
10	Klucz płaski 4,5 ZESPOL MIKRO Wrench ZESPOL MIKRO 4,5mm	760031	1
11	Klucz uniwersalny – MIKRO Universal spanner - MIKRO	760010	1
12	Paleta na instrumentarium ZESPOL MIKRO Tray for instruments ZESPOL MIKRO	540054	1
<b>Elementy dodatkowe / Additional elements</b>			
13	Paleta na implanty ZESPOL MIKRO Tray for implants ZESPOL MIKRO	540052	opcjonalnie optional
14	Kaseta sterylizacyjna Sterilization container	540016	opcjonalnie optional

### ZESTAW INSTRUMENTÓW ZESPOL MINI ZESPOL MINI – SET OF INSTRUMENTS

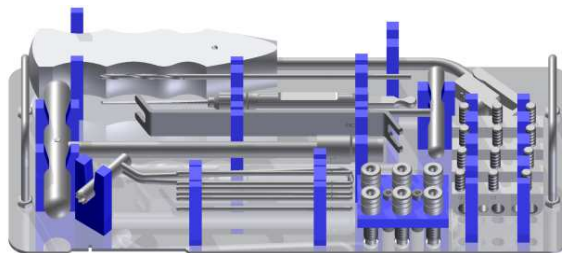

Lp.	Nazwa elementu / Description	Nr katalogowy Cat. No.	Ilość Quantity
1	Uchwyt prowadnicy kostkowej ZESPOL MINI Guide holder ZESPOL MINI	751030	1
2	Kostka 3-otworowa "0" ZESPOL MINI ZESPOL blocks MINI 3 holes compressing „0”	751034	2
3	Kostka 3-otworowa "1" ZESPOL MINI ZESPOL blocks MINI 3 holes compressing „1”	751035	1
4	Kostka 3-otworowa "2" ZESPOL MINI ZESPOL blocks MINI 3 holes compressing „2”	751036	1
5	Tulejka wiertarska Ø2,7mm Drilling sleeve Ø2,7mm	751127	6
6	Pręt ustalający Ø2,5mm ZESPOL seating rod Ø2,5mm	751128	6
8	Miarka głębokości L=50mm Depth gauge L=50mm	771020	1
7	Wiertło Ø2,7x150mm Drill Ø2,7x150mm	711027	1
9	Gwintownik Ø4,0x1,75mm Tap Ø4,0x1,75mm	720040	1
12	Ośłona gwintownika Ø4,0mm Tap sleeve Ø4,0mm	730040	1
10	Klucz płaski Flat spanner	760030	1
11	Klucz z pokrętką – mini Spanner with handle - mini	760020	1
13	Paleta na instrumentarium ZESPOL MINI Tray for instruments ZESPOL MINI	540051	1
<b>Elementy dodatkowe / Additional elements</b>			
14	Paleta na implanty ZESPOL MINI Tray for implants ZESPOL MINI	540050	opcjonalnie optional
15	Kaseta sterylizacyjna Sterilization container	540016	opcjonalnie optional

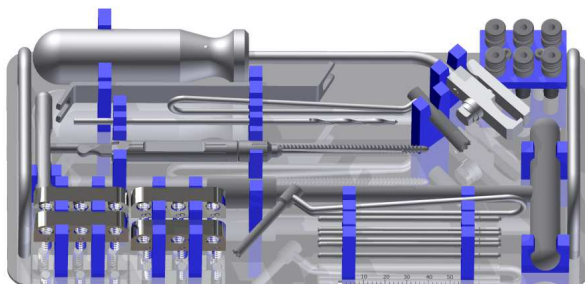

**ZESTAW INSTRUMENTÓW ZESPOL STANDARD**  
 ZESPOL STANDARD – SET OF INSTRUMENTS

Lp.	Nazwa elementu / Description	Nr katalogowy Cat. No.	Ilość Quantity
1	Uchwyt prowadnicy kostkowej ZESPOL STANDARD Guide holder ZESPOL STANDARD	751029	1
2	Kostka 3-otworowa "0" ZESPOL STANDARD ZESPOL blocks STANDARD 3 holes compressing „0”	751024	2
3	Kostka 3-otworowa "1" ZESPOL STANDARD ZESPOL blocks STANDARD 3 holes compressing „1”	751025	1
4	Kostka 3-otworowa "2" ZESPOL STANDARD ZESPOL blocks STANDARD 3 holes compressing „2”	751026	1
5	Tulejka wiertarska Ø3,2mm Drilling sleeve Ø3,2mm	751227	6
6	Pręt ustalający Ø3,0mm ZESPOL seating rod Ø3,0mm	751228	6
8	Miarka głębokości L=50mm Depth gauge L=50mm	771020	1
7	Wiertło Ø3,2x150mm Drill Ø3,2x150mm	711032	1
9	Gwintownik Ø4,5x1,75mm Tap Ø4,0x1,75mm	720045	1
12	Oslona gwintownika Ø4,5mm Tap sleeve Ø4,5mm	730045	1
10	Klucz płaski Flat spanner	760030	1
11	Klucz z pokrętką Spanner with handle i	761020	1
12	Prowadnica wiertła ø3,2 Drill guide ø3,2	750080	1
13	Paleta na instrumentarium ZESPOL STANDARD Tray for instruments ZESPOL STANDARD	540056	1
<b>Elementy dodatkowe / Additional elements</b>			
14	Paleta na implanty ZESPOL STANDARD Tray for implants ZESPOL STANDARD	540055	opcjonalnie optional
15	Kaseta sterylizacyjna Sterilization container	540016	opcjonalnie optional

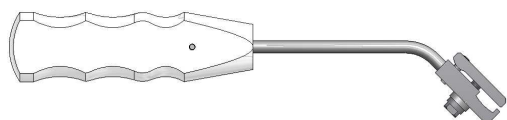

**Uchwyt prowadnicy kostkowej**  
Guide holder

Dla For	Nr katalogowy / Cat No
ZESPOL MIKRO	750029
ZESPOL MINI	751030
ZESPOL STANDARD	751029

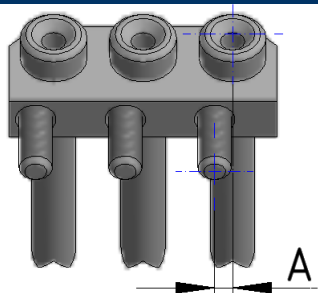

**Kostka 3-otworowa ZESPOL MIKRO**  
Block 3 holes ZESPOL MIKRO

A [mm]	Nr katalogowy / Cat No
0	750024
0,8	750025
1,6	750026

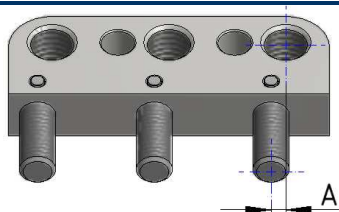

**Kostka 3-otworowa**  
Block 3 holes

A [mm]	Nr katalogowy / Cat No	
	ZESPOL MINI	ZESPOL STANDARD
0	751034	751024
1	751035	751025
2	751036	751026

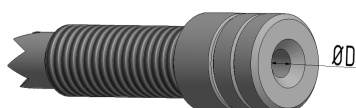

**Tulejka wiertarska**  
Drill sleeve

Dla For	øD	Nr katalogowy / Cat No
ZESPOL MIKRO	2,7	751127
ZESPOL MINI	3,2	751227



**Pręt ustalający**  
Fixing bar

Dla For	ØD	Nr katalogowy Cat No
ZESPOL MIKRO	Ø2,0	750028
ZESPOL MINI	Ø2,5	751128
ZESPOL STANDARD	Ø3,0	751228



**Miarka głębokości L=50mm**  
Depth gauge L=50mm

Nr katalogowy Cat No
771020



**Wiertło**  
Drill

Dla For	ØD	Nr katalogowy Cat No
ZESPOL MIKRO	Ø2,0	711020
ZESPOL MINI	Ø2,7	711027
ZESPOL STANDARD	Ø3,2	711032



**Gwintownik**  
Tap

Dla For	ØD	Nr katalogowy / Cat No
ZESPOL MIKRO	Ø2,7	720027
ZESPOL MINI	Ø4,0	720040
ZESPOL STANDARD	Ø4,5	720045

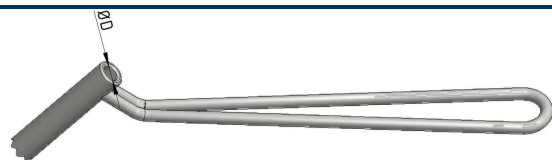

**Osłona gwintownika**  
Tap sleeve

Dla For	ØD	Nr katalogowy / Cat No
ZESPOL MIKRO	Ø2,7	730027
ZESPOL MINI	Ø4,0	730040
ZESPOL STANDARDI	Ø4,5	730045

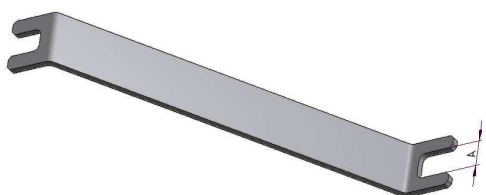

**Klucz płaski ZESPOL**  
Wrench ZESPOL

Dla For	A [mm]	Nr katalogowy / Cat No
ZESPOL MIKRO	4,5	760031
ZESPOL MINI	7,1	760030
ZESPOL STANDARD	8,1	760030

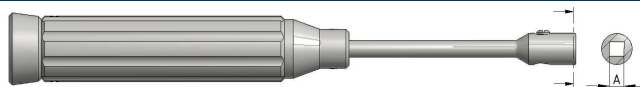

**Klucz ZESPOL MIKRO**  
Spanner ZESPOL MIKRO

A [mm]	Nr katalogowy / Cat No
4,5	760010

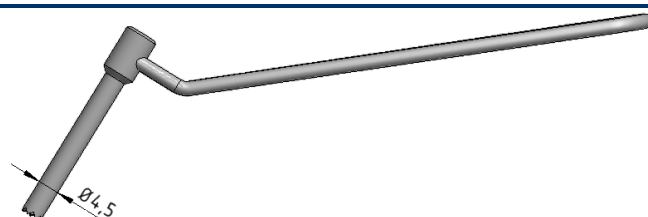

**Prowadnica wiertła Ø3,2 ZESPOL STANDARD**  
Drill guide Ø3,2 ZESPOL STANDARD

Nr katalogowy / Cat No

750080

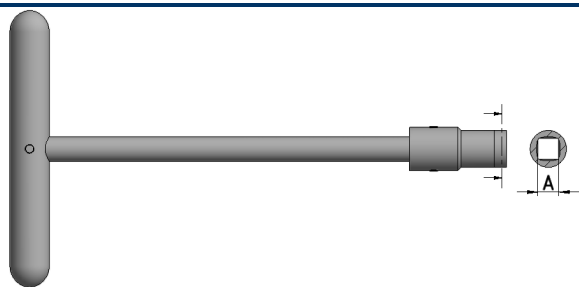

**Klucz ZESPOL**  
Spanner ZESPOL

Dla For	A [mm]	Nr katalogowy / Cat No
ZESPOL MINI	7,1	760020
ZESPOL STANDARD	8,1	761020

**Palety sterylizacyjne na implanty (bez implantów)**  
Sterilization trays for implants (without implants)

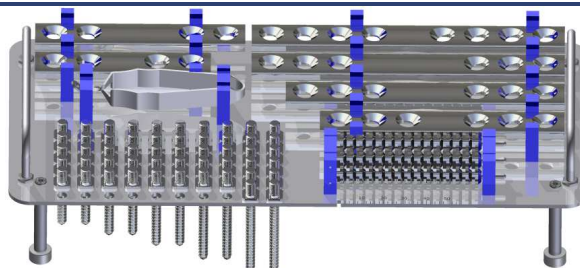
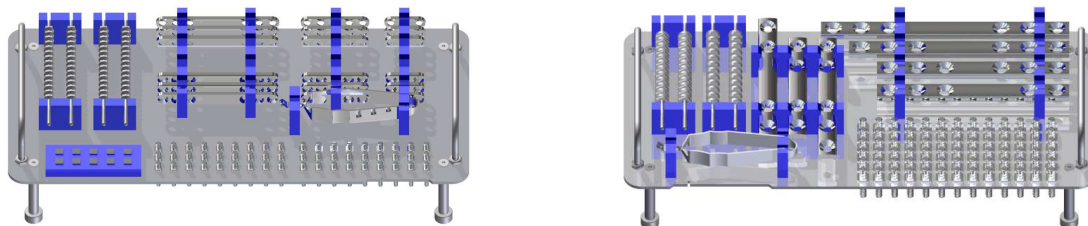

Nazwa/ Description	Kaseta sterylizacyjna/ Sterilization container	Nr katalogowy/ Cat No
Paleta na implanty ZESPOL MIKRO Tray for implants ZESPOL MIKRO	540016	540052
Paleta na implanty ZESPOL MINI Tray for implants ZESPOL MINI	540016	540050
Paleta na implanty ZESPOL STANDARD Tray for implants ZESPOL STANDARD	540016	540055

**Palety sterylizacyjne do zestawu narzędzi (bez narzędzi)**  
 Sterilization trays for set of instruments (without instruments)

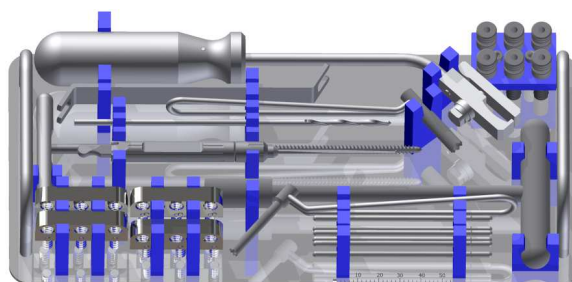
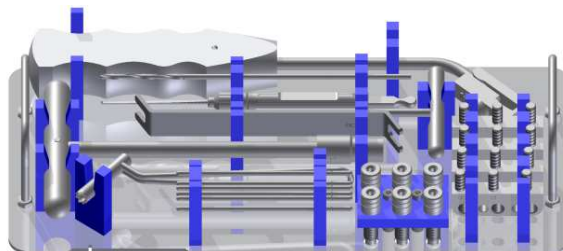
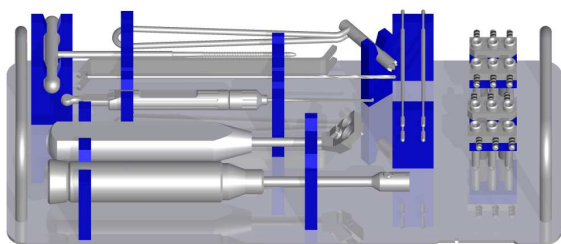

Nazwa/ Description	Kaseta sterylizacyjna/ Sterilization container	Nr katalogowy/ Cat No
Paleta na instrumentarium ZESPOL MIKRO Tray for instruments ZESPOL MIKRO	540016	540054
Paleta na instrumentarium ZESPOL MINI Tray for instruments ZESPOL MINI	540016	540051
Paleta na instrumentarium ZESPOL STANDARD Tray for instruments ZESPOL STANDARD	540016	540056

## INSTRUMENTY/ INSTRUMENTS

## WKREŃTAKI/ SCREWDRIVERS



Wkrętak heksagonalny  
Hexagonal screwdriver

Ø wkręta/ Ø of screw	L [mm]	S [mm]	Nr katalogowy/ Cat No
1,5-2,0	80	1,5	780200
2,4	80	2,0	781201
2,7-4,0	120	2,5	781200
4,5-6,5	120	3,5	782200

## WIERTŁA/ DRILLS

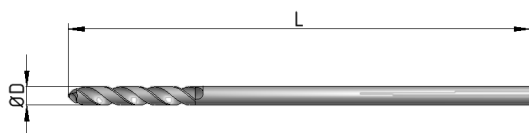

Wiertło  
Drill

ØD [mm]	L [mm]	Nr katalogowy/ Cat No.
1,0	90	711010
1,5	100	711015
2,0	150	711020
2,2	150	711022
2,5	150	711025
2,7	150	711027
3,0	150	711030
3,2	150	711032
3,5	150	711035
3,7	150	711037

ØD [mm]	L [mm]	Nr katalogowy/ Cat No.
4,0	150	711040
4,2	150	711042
4,5	150	711045
4,7	150	711047
5	150	711050
6	150	711060
7	150	711070



## PROWADNIKI/ GUIDES

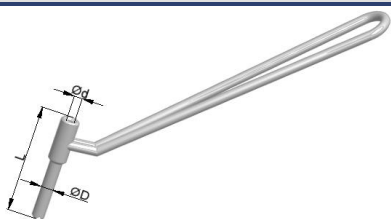

**Prowadnik wiertła**  
Drill guide

Ød wiertła [mm] Ød of drill [mm]	ØD [mm]	L [mm]	Nr katalogowy/ Cat No
1,0	2,5	25	750070
1,5	3,0	25	750073
2,0	4,0	35	750074
2,5	4,0	35	750075
3,0	5,0	35	750079
3,2	4,5	35	750072
3,7	5,0	35	750077
3,2	6,5	40	750071
4,2	6,5	40	750082
4,7	7,0	45	750081



**Celownik do płyt kompresyjnych  
otwory samodociskowe**  
Drill guide for compression plates  
self-compressing holes

ØD [mm]	Ød wiertła [mm] Ød of drill [mm]	Nr katalogowy/ Cat No
10	3,2	750200
8	2,0	750201
8	2,0	750202
8	2,5	750211

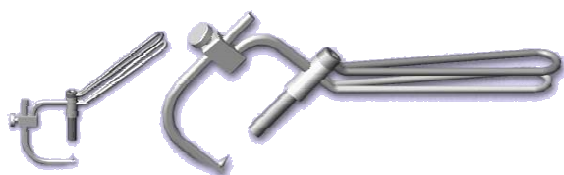

**Prowadnik centrujący**  
Centering guide

Opis/ Description		Nr katalogowy/ Cat No
Prowadnik centrujący – komplet Centering guide - set		750700
1	Tuleja Ø4,5mm Sleeve Ø4,5mm	750701
2	Tuleja Ø3,2mm Sleeve Ø3,2mm	750702
3	Tuleja Ø2,0mm Sleeve Ø2,0mm	750703
4	Korpus prowadnika centrującego Body of the centering guide	750704

## GWINTOWNIKI/ TAPS

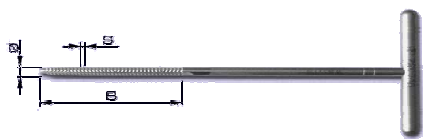

Gwintownik z pokrętką  
Tap with T-handle

Ø [mm]	S [mm]	B [mm]	Nr katalogowy/ Cat No
1,5/1,0	0,5	20	720015
2,0/1,3	0,6	20	720020
2,7/1,9	1,0	27	720027
3,5/1,9	1,25	45	720035
3,5/2,4	1,25	50	720235
4,0/1,9	1,75	50	720140
4,5/3,0	1,75	70	720045

## OSŁONY GWINTOWNIKÓW/ TAP SLEEVES



Osłona gwintownika  
Tap sleeve

Dla gwintownika For tap	Ød [mm]	G=12mm	L[mm]	Nr katalogowy/ Cat No
1,5	1,7	6	25	730015
2	2,2	6	25	730020
2,7	2,9	6	35	730027
3,5	3,7	6	35	730035
4	4,4	7	35	730040
4,5	4,7	7	40	730045

## MIARKI/ GAUGES



**Miarka głębokości**  
Depth gauge

Dla wkrętów For screws	Zakres pomiarowy [mm] Measuring range [mm]	Nr katalogowy/ Cat No
Ø1,5 - Ø2,7	40	772020
Ø3,5 - Ø5,0	50	772030
Ø3,5 - Ø6,5	90	772040

## WYGINAKI/ BENDING INSTRUMENTS

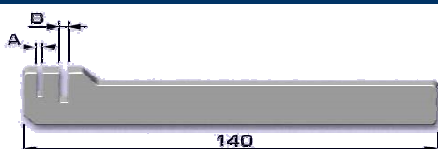

**Wyginak płytek 1,5mm i 2,5mm**  
Bending iron for plates 1,5mm and 2,5mm

A [mm]	B [mm]	Nr katalogowy/ Cat No
1,5	2,5	790530
2,5	1,5	790531

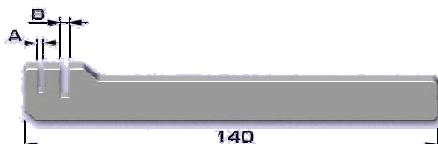

**Wyginak płytek 2,7mm i 3,5mm**  
Bending iron for plates 2,7mm and 3,5mm

A [mm]	B [mm]	Nr katalogowy/ Cat No
2,7	3,5	790534
3,5	2,7	790535

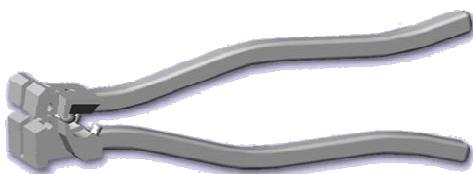

**Wyginak płytek rekonstrukcyjnych**  
Bending iron for reconstruction plates

Nr katalogowy/ Cat No

790543

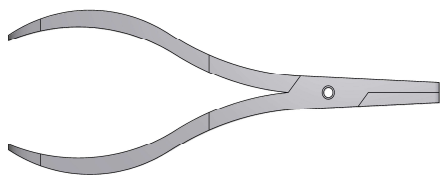

**Wyginak go płytek drobnych**  
Bending pliers for small plates

Nr katalogowy/ Cat No

470020

## KLESZCZE/ FORCEPS



**Kleszcze do ucinania gwoździ do 3,6mm**  
Forceps for nails cutting up to 3,6mm

Nr katalogowy/ Cat No

419005



**Boczne kleszcze do ucinania gwoździ do 2,4mm**  
Lateral forceps for cutting nails up to 2,4mm

Nr katalogowy/ Cat No

419030

## UCHWYTY/ HANDLES

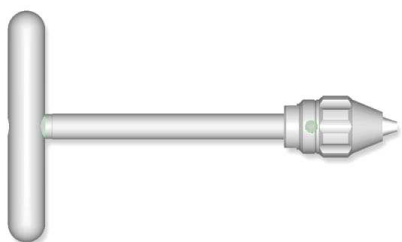

**Uchwyt do gwoździ**  
Handle for nails

Nr katalogowy/ Cat No

763006

INNE/ OTHERS

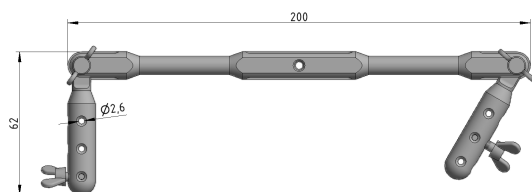

**Uchwyt do osteotomii**  
Holder for osteotomy

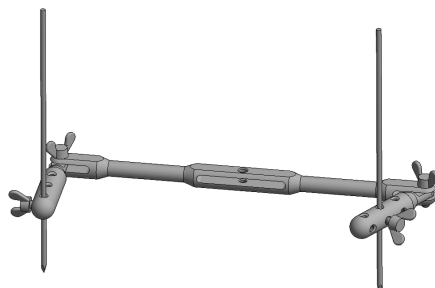

Nazwa Name		Sztuk w zestawie Pieces in set	Nr katalogowy Catalogue no.
Uchwyt do osteotomii (komplet)		1	900015
1.	Ramię główne	1	900015/1
2.	Ramię boczne	2	900015/2
3.	Śruba skrzydełkowa	4	900015/3
4.	Drut Kirschnera M2,5x150mm	2	312501



**Kontener sterylizacyjny**  
Sterilization container

Długość x Szerokość x wysokość[mm] (wymiary wewnętrzne) Length x Width x Height [mm] (internal dimensions)	Nr katalogowy/ Catalog
280x130x55	540015
280x130x84	540016

## DOBÓR KĄTA TPŁO TPLO ROTATION – REFERENCE CHART

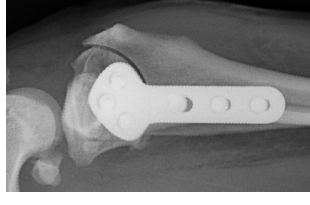

### KĄT TPA PRZED ZABIEGIEM PREOPERATIVE TIBIAL PLATEAU ANGLE (TPA)

	15°	16°	17°	18°	19°	20°	21°	22°	23°	24°	25°	26°	27°	28°	29°	30°	31°	32°	33°	34°	35°	36°	37°	38°	39°	40°
--	-----	-----	-----	-----	-----	-----	-----	-----	-----	-----	-----	-----	-----	-----	-----	-----	-----	-----	-----	-----	-----	-----	-----	-----	-----	-----

### ROTACJA W MM ZAPEWNIAJĄCA REDUKCJĘ KĄTA DO 5° ROTATION [MM] – PROVIDES RESULT 5° TPA

	2.0	2.2	2.4	2.6	2.9	3.1	3.3	3.5	3.7	3.9	4.1	4.3	4.5	4.7	4.9	5.1	5.3	5.5	5.7	5.9	6.1	6.3	6.4	6.6	6.8	7.0
12mm	2.0	2.2	2.4	2.6	2.9	3.1	3.3	3.5	3.7	3.9	4.1	4.3	4.5	4.7	4.9	5.1	5.3	5.5	5.7	5.9	6.1	6.3	6.4	6.6	6.8	7.0
15mm	2.6	2.8	3.1	3.3	3.6	3.8	4.1	4.3	4.6	4.9	5.1	5.4	5.6	5.9	6.1	6.4	6.6	6.9	7.1	7.4	7.6	7.9	8.1	8.4	8.6	8.8
18mm	3.1	3.4	3.7	4.0	4.3	4.6	4.9	5.2	5.5	5.8	6.1	6.5	6.8	7.1	7.4	7.7	8.0	8.3	8.6	8.9	9.2	9.5	9.8	10.1	10.3	10.6
21mm	3.6	4.0	4.3	4.7	5.0	5.4	5.8	6.1	6.5	6.8	7.2	7.5	7.9	8.3	8.6	9.0	9.3	9.7	10.0	10.4	10.7	11.1	11.4	11.8	12.1	12.4
24mm	4.1	4.5	5.0	5.4	5.8	6.2	6.6	7.0	7.4	7.8	8.2	8.6	9.0	9.5	9.9	10.3	10.7	11.1	11.5	11.9	12.3	12.7	13.1	13.5	13.9	14.3
27mm	4.7	5.1	5.6	6.0	6.5	7.0	7.4	7.9	8.4	8.8	9.3	9.7	10.2	10.6	11.1	11.6	12.0	12.5	12.9	13.4	13.8	14.3	14.7	15.2	15.6	16.1
30mm	5.2	5.7	6.2	6.7	7.2	7.8	8.3	8.8	9.3	9.8	10.3	10.8	11.3	11.8	12.3	12.9	13.4	13.9	14.4	14.9	15.4	15.9	16.4	16.9	17.4	17.9

ROZMIAR OSTRZA / SAW RADIUS



## DOBÓR IMPLANTÓW TTA SELECTION OF TTA IMPLANTS

**WAGA PACJENTA**  
PATIENT WEIGHT

**ROZMIAR KOSTKI**  
CAGE SIZE

*(Pod wkręty 2,4 albo 2,7/  
Use with 2,4 or 2,7 screws)*

**DŁUGOŚĆ PŁYTKI**  
LENGTH OF PLATE

*(Do części bliższej wkręty 2,4mm/  
For proximal holes 2,4mm screws)*

**WKRETY DO CZĘŚCI DALSZEJ PŁYTEK**  
SCREWS FOR DISTAL HOLES

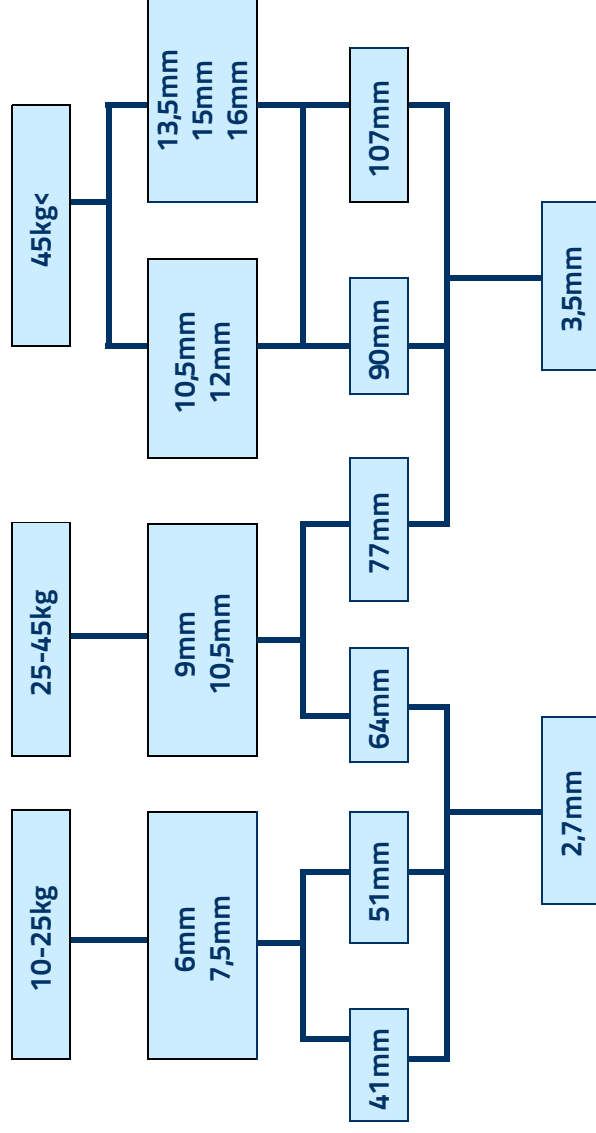





## REKOMENDOWANE NARZĘDZIA DO IMPLANTACJI WKRĘTÓW BHH MIKROMED RECOMMENDED INSTRUMENTS FOR BHH MIKROMED SCREWS IMPLANTATION

Wkręty lite	Wiertło z chwytem walcowym	Gwintownik z pokrętką	Wkrętaki z uchwytem
Ø1,5 / Ø1,0	Ø1,0	Ø1,5 / Ø1,0 x 0,5	S1,5
	711010	720015	780200
Ø2,0 / Ø1,3	Ø1,5	Ø2,0 / Ø1,3 x 0,6	S1,5
	711015	721020	780200
Ø2,7 / Ø1,9	Ø2,0	Ø2,7 / Ø1,9 x 1,0	S2,5
	711020	720027	781200
Ø3,5 / Ø1,9	Ø2,0	Ø3,5 / Ø1,9 x 1,25	S2,5
	711020	720035	781200
Ø3,5 / Ø2,4	Ø2,5	Ø3,5 / Ø2,4 x 1,25	S2,5
	711025	720235	781200
Ø4,0 / Ø1,9	Ø2,0	Ø4,0 / Ø1,9 x 1,75	S2,5
	711020	720140	781200
Ø4,5 / Ø3,0	Ø3,2	Ø4,5 / Ø3,0 x 1,75	S3,5
	711032	720045	782200
Ø6,5 / Ø3,0	Ø3,2	Ø6,5 / Ø3,0 x 2,75	S3,5
	711032	720065	782200









## TABELA DOBORU ŚREDNICY WKRETA WZGLĘDEM WAGI PACJENTA

### CHART OF SCREW DIAMETER RELATIVE TO PATIENTS WEIGHT

	kg:	1	2	3	4	5	6	7	8	9	15	20	25	30	35	40	45	50	55	60	65	70	75	80
<b>Śródreżce / Śródstopie</b> Metacarpus / Metatarsus											2.0								2.7					
<b>Kość piszczelowa</b> Tibia							1.5	2.4			2.0		2.4			3.5				4.5				
<b>Kość udowa</b> Femur							2.0	2.4		2.7			3.5			3.5				4.5				
<b>Miednica</b> Pelvis							2.0	2.4		2.7			2.7			3.5				3.5				
<b>Kość promieniowa</b> Radius							2.0	2.4		2.7			3.5			3.5				4.5				
<b>Kość łokciowa</b> Ulna							1.5	2.4		2.0			2.4			2.7				3.5				
<b>Kość ramienna</b> Humerus							2.0	2.4		2.7			3.5			3.5				4.5				
<b>Łopatką</b> Scapula							2.0	2.4		2.7			2.7			3.5				3.5				



## SPIS OZNACZEŃ KOLORYSTYCZNYCH NARZĘDZI SYSTEMÓW PŁYTEK BLOKOWANYCH COLOUR CODING OF LOCKING SYSTEM INSTRUMENTS

SYSTEM	2,4 SYSTEM Mikromed Locking Plates			3,5 SYSTEM Mikromed Locking Plates		
	Ø2,4mm	Ø2,7mm	Ø2,7mm	Ø2,7mm	Ø3,5mm	Ø4,0mm
ŚREDNICA GWINTU THREAD DIAMETER						
TYP WKRETA SCREW TYPE	LITY/ SOLID	LITY/ SOLID	LITY/ SOLID	LITY/ SOLID	LITY/ SOLID	LITY/ SOLID
KOLOR WKRETA (TYLKO WERSJA TYTANOWA) SCREW COLOUR (ONLY TITANIUM VERSION)	ZIEŁONY/ GREEN	MAGENTA	ZIEŁONY/ GREEN	MAGENTA	ŻÓŁTY/ YELLOW	ŻÓŁTY/ YELLOW
						
ŚREDNICA WKRETA SCREW DIAMETER	Ø2,0mm	Ø2,2mm	Ø2,0mm	Ø2,2mm	Ø3,0mm	Ø3,0mm
NR KAT WIERTŁA CAT NO OF SCREW	712120	712122	712120	712122	712130	712130
KOLOR WIERTŁA DRILL COLOUR	ZIEŁONY/ GREEN	MAGENTA	ZIEŁONY/ GREEN	MAGENTA	ŻÓŁTY/ YELLOW	ŻÓŁTY/ YELLOW
NR KAT PROWADNICY WIERTŁA CAT NO OF DRILL GUIDE	075055	075056	750014	075057	075060	075060
KOLOR PROWADNICY GUIDE COLOUR	ZIEŁONY/ GREEN	MAGENTA ZIEŁONY/ GREEN	ZIEŁONY/ GREEN	MAGENTA ŻÓŁTY/ YELLOW	ŻÓŁTY/ YELLOW	ŻÓŁTY/ YELLOW
ROZMIAR KOŃCÓWKI WKRETA SCREWDRIVER TIP SIZE	S1,5		S2,5			
NR KAT WKRETA CAT NO OF SCREWDRIVER	783115		783125			
KOLOR WKRETA SCREWDRIVER COLOUR	ZIEŁONY/ GREEN		ŻÓŁTY/ YELLOW			







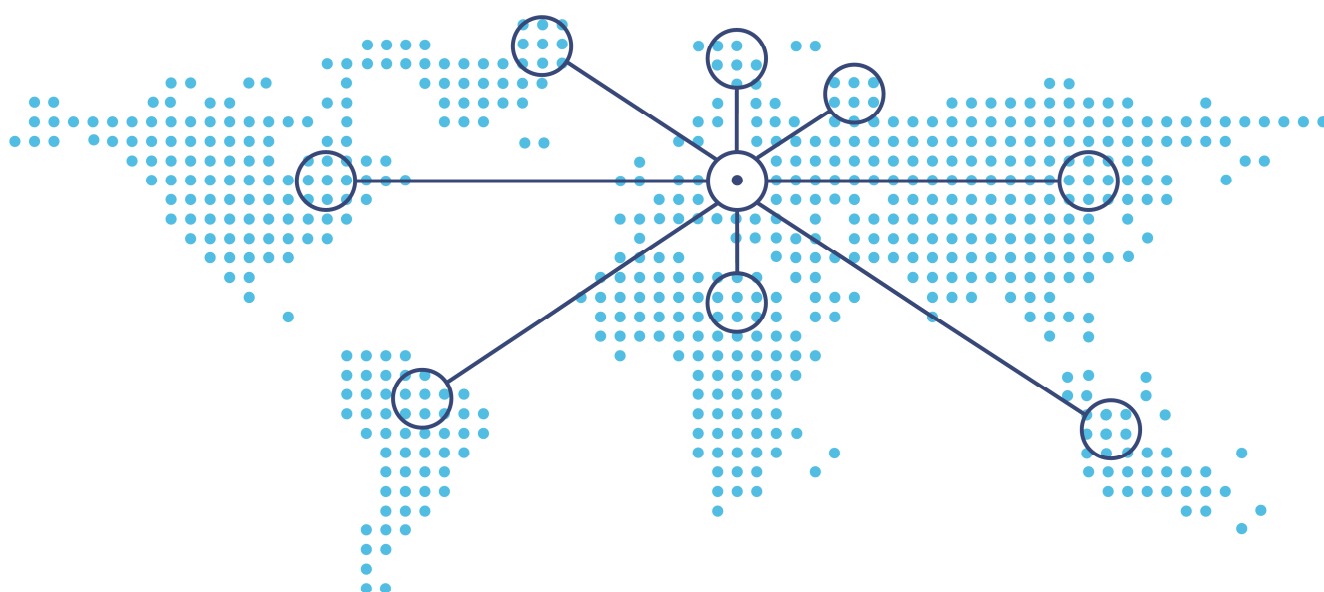

## Kontakt Contact

---

**BHH MIKROMED** Sp. z o.o.,  
ul. Katowicka 11, 42-530 Dąbrowa Górnicza; Poland  
tel. /+48 / 32 / 262 52 85,  
      /+48 / 32 / 261 02 20,  
      /+48 / 505 453 146,  
fax /+48 / 32 / 246 68 85,  
[www.mikromed.pl](http://www.mikromed.pl)