

 **BHH MIKROMED4vet**



WETERYNARIA

VETERINARY

BHH Mikromed sp. z o.o. zastrzega sobie prawo do wprowadzania zmian, wygląd produktu może nieznacznie różnić się od przedstawionego na ilustracji
Wszystkie treści, materiały oraz elementy graficzne umieszczone w tym dokumencie są własnością intelektualną firmy BHH Mikromed sp. z o.o.

BHH Mikromed Sp. z o.o. reserves the right to make changes, the design of the product may slightly differ from the picture.
All content, materials and graphic elements placed in this document are the intellectual property of BHH Mikromed Sp. z o.o.

SPIS TREŚCI / CONTENT

PŁYTKA DO STAWU SKOKOWEGO/ PLATE FOR MEDIAL PANTARSAL ARTHRODESIS	2
PŁYTKA DO ARTRODEZY NADGARSTKA/ ARTHRODESIS PLATE FOR WRIST	2
PŁYTKI TPLO/ TPLO PLATES	3
PŁYTKI TPO/ TPO PLATES	5
GWOŹDZIE RYGLOWANE N-LOCK/ N-LOCK INTERLOCKING NAILS.....	6
GWOŹDZIE RYGLOWANE N-LOCK/ N-LOCK INTERLOCKING NAILS.....	11
TTA	16
CAUDA EQUINA DECOMPRESSION SCREW	20
SYSTEM WKRĘTÓW KOMPRESYJNYCH/ COMPRESSION SCREW SYSTEM	22
SYSTEM PŁYTEK KOMPRESYJNO-BLOKOWANYCH/ LOCKING - COMPRESSION PLATE SYSTEM	23
PŁYTKI PROSTE/ STRAIGHT PLATES	37
PŁYTKI KSZTAŁTOWE/ SHAPED PLATES.....	40
PŁYTKI REKONSTRUKCYJNE/ RECONSTRUCTION PLATES	44
PŁYTKA SIATKOWA/ MESH PLATE	46
PŁYTKA DO KOREKCJI NASAD KOŚCI PISZCZELOWYCH W FAZIE WZROSTU/ PLATE FOR CORRECTION OF TIBIA EPIPHYSIS IN THE GROWT PHASE	46
WKRĘTY/ SCREWS	47
PODKŁADKI/ WASHERS	52
DRUTY/ WIRES	53
GROTOWKRĘTY/ PINS	56
SYSTEM ZESPOL.....	58
INSTRUMENTY/ INSTRUMENTS.....	69
WKRĘTAKI/ SCREWDRIVERS	69
WIERTŁA/ DRILLS.....	69
PROWADNIKI/ GUIDES	70
GWINTOWNIKI/ TAPS	71
OSŁONY GWINTOWNIKÓW/ TAP SLEEVES	71
MIARKI/ GAUGES.....	72
WYGINAKI/ BENDING INSTRUMENTS	72
KLESZCZE/ FORCEPS	73
UCHWYTY/ HANDLES	73
INNE/ OTHERS	74
DOBÓR KĄTA TPLO TPLO ROTATION – REFERENCE CHART	75
DOBÓR IMPLANTÓW TTA SELECTION OF TTA IMPLANTS	76
REKOMENDOWANE NARZĘDZIA DO IMPLANTACJI WKRĘTÓW BHH MIKROMED RECOMMENDED INSTRUMENTS FOR BHH MIKROMED SCREWS IMPLANTATION.....	77
TABELA DOBORU ŚREDNICY WKRĘTA WZGLĘDEM WAGI PACJENTA CHART OF SCREW DIAMETER RELATIVE TO PATIENTS WEIGHT	78
SPIS OZNACZEŃ KOLORYSTYCZNYCH NARZĘDZI SYSTEMÓW PŁYTEK BLOKOWANYCH COLOUR CODING OF LOCKING SYSTEM INSTRUMENTS.....	79



Dołącz do
nas na facebooku
Mikromed – weterynaria

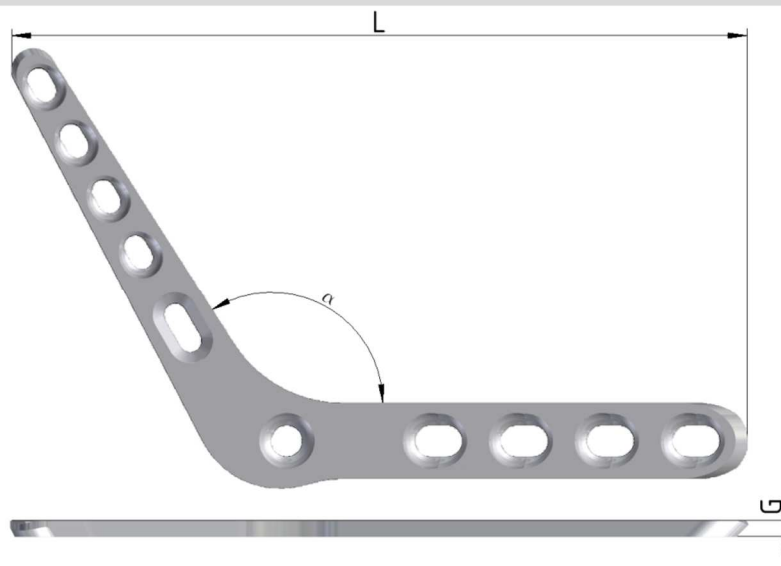

**PŁYTKA DO STAWU SKOKOWEGO/
PLATE FOR MEDIAL PANTARSAL ARTHRODESIS**

α [°]	L [mm]	G [mm]	Pod wkręty For screws	Nr katalogowy Cat No	
				Prawa/ Right	Lewa/ Left
120°	68	1,5	2,0 -2,7	010316	010315
135°	74	1,5	2,0 - 2,7	010318	010317
135°	97	2,0	2,0 - 2,7	010352	010350
140°	128	3,0	2,0 - 2,7	010356	010354
140°	128	3,0	2,7 - 3,5	010360	010358
140°	145	3,0	2,7 - 3,5	010364	010362
140°	185	3,0	2,7 - 4,5	010368	010366

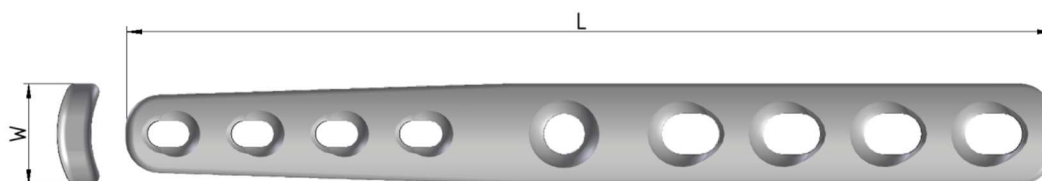
**PŁYTKA DO ARTRODEZY NADGARSTKA/
ARTHRODESIS PLATE FOR WRIST**

Dla wkrętów For screws	L [mm]	W [mm]	Nr katalogowy Cat No
Ø2,0/Ø1,5	55	6	010430
Ø2,7/Ø2,4	75	8	010432
Ø3,5/Ø2,7	100	10,2	010434
Ø4,0/Ø3,5	120	11,5	010436

PŁYTKI TPLO/ TPLO PLATES

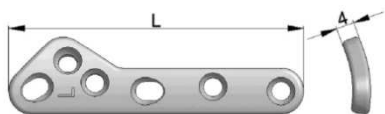

Płytką TPLO pod wkręty $\varnothing 3,5$ mm i $\varnothing 4,0$ mm
TPLO Plate for screws $\varnothing 3,5$ mm and $\varnothing 4,0$ mm

Ilość otworów No. holes	L [mm]	Nr katalogowy/ Cat No	
		Lewa/ Left	Prawa/ Right
6	55	012720	012710
7	75	012740	012730

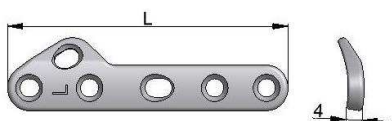

Płytką TPLO pod wkręty $\varnothing 3,5$ mm i $\varnothing 4,0$ mm
TPLO Plate for screws $\varnothing 3,5$ mm and $\varnothing 4,0$ mm

Ilość otworów No. holes	L [mm]	Nr katalogowy/ Cat No			
		Lewa/ Left		Prawa/ Right	
		SS	Ti	SS	Ti
6	55	012930	012930T	012940	012940T

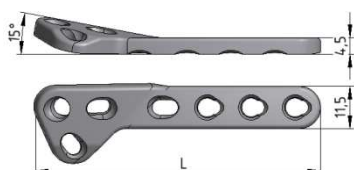

Płytką blokowaną TPLO pod wkręty SYSTEM 3,5
TPLO locking plate for screw SYSTEM 3,5

Ilość otworów No. holes	L [mm]	Nr katalogowy/ Cat No			
		Lewa/ Left		Prawa/ Right	
		SS	Ti	SS	Ti
7	78	012950	012950T	012960	012960T

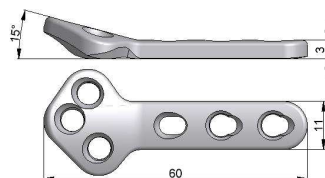

Płytką blokowaną TPLO pod wkręty SYSTEM 3,5
TPLO locking plate for screw SYSTEM 3,5

Nr katalogowy / Catalogue No			
Lewa/ Left		Prawa/ Right	
SS	Ti	SS	Ti
010215	010215T	010216	010216T

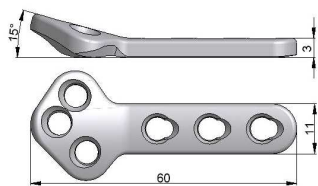

Płytką blokowaną TPLO pod wkręty SYSTEM 3,5
TPLO locking plate for screw SYSTEM 3,5

Nr katalogowy/ Cat No			
Lewa/ Left		Prawa/ Right	
SS	Ti	SS	Ti
010217	010217T	010218	010218T

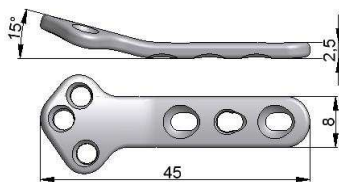

Płytką blokowaną TPLO pod wkręty SYSTEM 2,4
TPLO locking plate for screw SYSTEM 2,4

Nr katalogowy / Catalogue No			
Lewa/ Left		Prawa/ Right	
SS	Ti	SS	Ti
010222	010222T	010223	010223T

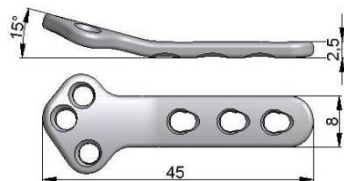

Płytką blokowaną TPLO pod wkręty SYSTEM 2,4
TPLO locking plate for screw SYSTEM 2,4

Nr katalogowy/ Cat No			
Lewa/ Left		Prawa/ Right	
SS	Ti	SS	Ti
010228	010228T	010229	010229T

PŁYTKI TPO/ TPO PLATES

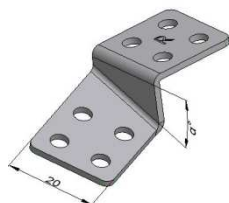

Płytki TPO pod wkręty $\varnothing 3,5$ mm i $\varnothing 4,0$ mm i $\varnothing 4,5$ mm
 TPO plates for screws $\varnothing 3,5$ mm and $\varnothing 4,0$ mm and $\varnothing 4,5$ mm

α [°]	Ilość otworów No. holes	L [mm]	Nr katalogowy/ Cat No			
			\varnothing of screw=3,5mm/ \varnothing of screw=4mm		\varnothing of screw=4,5 mm	
			Lewa/ Left	Prawa/ Right	Lewa/ Left	Prawa/ Right
20	8	55	010220	010221	010320	010321
25	8	55	010225	010226	010325	010326
30	8	55	010230	010231	010330	010331
35	8	55	010235	010236	010335	010336

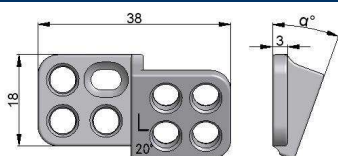

Płytki blokowane TPO / DPO pod wkręty SYSTEM 3,5
 TPO / DPO locking plate for screw SYSTEM 3,5

α [°]	Ilość otworów No. holes	Nr katalogowy/ Cat No			
		Lewa / Left		Prawa / Right	
		SS	Ti	SS	Ti
20	7+1	010202	010202T	010208	010208T
25	7+1	010203	010203T	010209	010209T
30	7+1	010204	010204T	010210	010210T
35	7+1	010205	010205T	010211	010211T

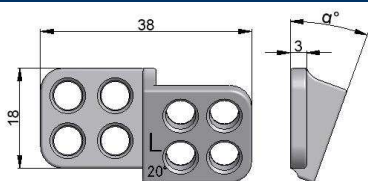

Płytki blokowane TPO /DPO pod wkręty SYSTEM 3,5
 TPO / DPO locking plate for screw SYSTEM 3,5

α [°]	Ilość otworów No. holes	Nr katalogowy/ Cat No			
		Lewa/ Left		Prawa/ Right	
		SS	Ti	SS	Ti
20	8	010252	010252T	010258	010258T
25	8	010253	010253T	010259	010259T
30	8	010254	010254T	010260	010260T
35	8	010255	010255T	010261	010261T

GWOŹDZIE RYGLOWANE N-LOCK/ N-LOCK INTERLOCKING NAILS

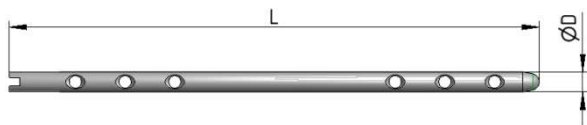

Gwoździe ryglowane N-Lock
N-Lock interlocking nails

L [mm]	Nr katalogowy Cat No					
	ØD = 6 mm		ØD = 7 mm		ØD = 8 mm	
	SS	Ti	SS	Ti	SS	Ti
130	031613	031613T	031713	031713T	031813	031813T
145	031614	031614T	031714	031714T	031814	031814T
160	031616	031616T	031716	031716T	031816	031816T
175	031617	031617T	031717	031717T	031817	031817T
190	031619	031619T	031719	031719T	031819	031819T
205	031620	031620T	031720	031720T	031820	031820T
220	031622	031622T	031722	031722T	031822	031822T

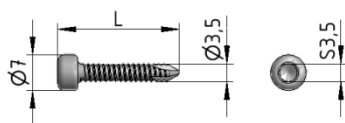

Wkręt ryglujący Ø3,5mm pełnogwintowany, samogwintujący
Locking screw Ø3,5mm, fully threaded, self-tapping

L [mm]	Nr katalogowy Cat No	
	SS	Ti
20	294454	294454T
22	294456	294456T
24	294458	294458T
25	294459	294459T
26	294460	294460T
28	294462	294462T
30	294464	294464T

L [mm]	Nr katalogowy Cat No	
	SS	Ti
32	294466	294466T
34	294468	294468T
35	294469	294469T
36	294470	294470T
38	294472	294472T
40	294474	294474T



Wkręt zaślepiający M4
M4 End cap

Do gwoździ For nails	Nr katalogowy Cat No	
	SS	Ti
Ø8	029000	029000T
Ø7	029020	029020T
Ø6	029010	029010T

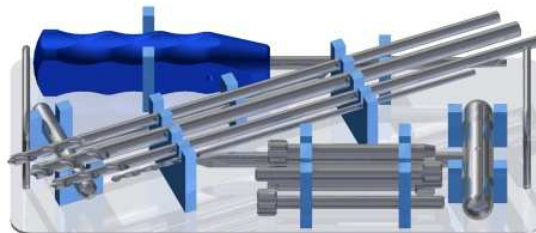
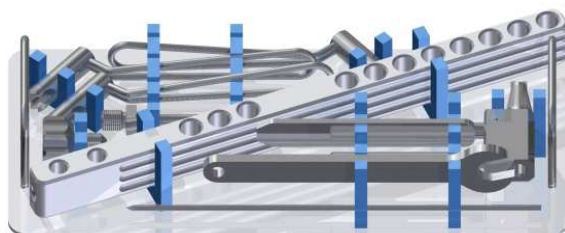
GWOŹDZIE WETERYNARYJNE – ZESTAW INSTRUMENTÓW
VETERINARY NAILS – INSTRUMENTS SET

Lp.	Nazwa elementu / Description	Nr katalogowy Cat No	Ilość Pcs
1	Prowadnica do gwoździ weterynaryjnych – komplet Veterinary targeting device - set	075300	1
2	Trokar Ø3,0mm Trocar Ø3,0mm	079006	1
3	Trokar Ø8,0mm Trocar Ø8,0mm	079060	1
4	Wiertło Ø3,0mm Drill Ø3,0mm	711930	1
5	Wiertło Ø6,0mm Drill Ø6,0mm	071206	1
6	Wiertło Ø7,0mm Drill Ø7,0mm	071207	1
7	Wiertło Ø8,0mm Drill Ø8,0mm	071208	1
8	Klucz płaski S13 Flat wrench S13	761330	1
9	Wkrętak heksagonalny S3.5 Hexagonal screwdriver S3.5	782200	1
10	Tuleja wiertarska Ø3,0mm Drill sleeve Ø3,0mm	075193	2
11	Tuleja ochronna Ø7,0mm Protection sleeve Ø7,0mm	075194	2
12	Miarka długości wkrętów Length gauge for screws	770115	1
13	Tuleja wiertarska Ø6,0mm Protection sleeve Ø6,0mm	075051	1
14	Tuleja wiertarska Ø7,0mm Protection sleeve Ø7,0mm	075052	1
15	Tuleja wiertarska Ø8,0mm Protection sleeve Ø8,0mm	075053	1
16	Wbijak – wybijak Impactor - extractor	075320	1
17	Drut Kirschnera M3x200mm Kirschner Wire M3x200mm	313004	2
18	Paleta 1 Tray 1	540040	1
19	Paleta 2 Tray 2	540041	1
Elementy dodatkowe / Additional elements			
20	Paleta na gwoździe weterynaryjne Ø6.0mm Tray for veterinary nails Ø6.0mm	540046	Opcjonalnie Optional
21	Paleta na gwoździe weterynaryjne Ø7.0mm Tray for veterinary nails Ø7.0mm	540047	Opcjonalnie Optional
22	Paleta na gwoździe weterynaryjne Ø8.0mm Tray for veterinary nails Ø8.0mm	540048	Opcjonalnie Optional
23	Kaseta sterylizacyjna Sterilization container	540016	opcjonalnie optional



Prowadnica do gwoździ weterynaryjnych – komplet
Veterinary targeting device - set

Nr katalogowy
Cat No

075300



Trokar
Trocar

ØD [mm]	Nr katalogowy Cat No
Ø3,0	079006
Ø8,0	079060

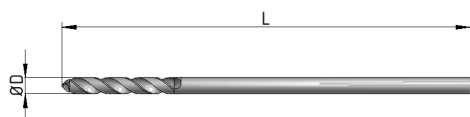

Wiertło
Drill

ØD [mm]	L [mm]	Nr katalogowy Cat No
Ø3,0	200	711930
Ø6,0	270	071206
Ø7,0	270	071207
Ø8,0	270	071208



Klucz płaski S13
Flat wrench S13

Nr katalogowy
Cat No

761330

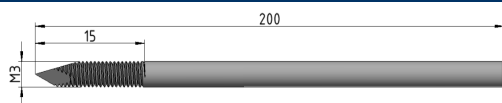

Drut Kirschnera M3x200mm
Kirschner Wire M3x200mm

Nr katalogowy/ Cat No

313004



Wkrętak heksagonalny S3,5 lity
Hexagonal screwdriver S3,5 solid

L [mm]	S [mm]	Nr katalogowy Cat No
120	3,5	782200



Tuleja wiertarska Ø3,0mm
Drill sleeve Ø3,0mm

Nr katalogowy
Cat No

075193



Tuleja ochronna Ø7,0mm
Protection sleeve Ø7,0mm

Nr katalogowy
Cat No

075194

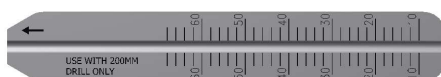

Miarka długości wkrętów
Length gauge for screws

Nr katalogowy
Cat No

770115

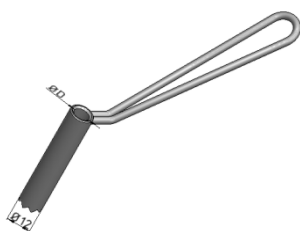

Tuleja ochronna
Protection sleeve

ØD [mm]	Nr katalogowy Cat No
6,0	075051
7,0	075052
8,0	075053



Wbijak - wybijak
Impactor - extractor

Nr katalogowy
Cat No

075320

Palety sterylizacyjne do zestawu narzędzi do gwoździ weterynaryjnych (bez narzędzi)
Sterilization trays for set of instruments for veterinary nail (without instruments)

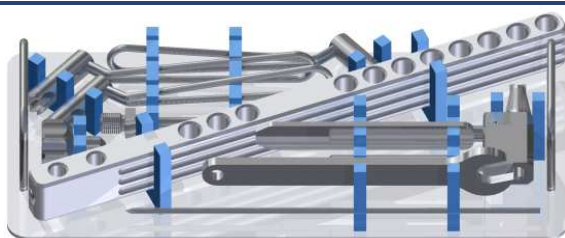

Paleta 1/ Tray 1

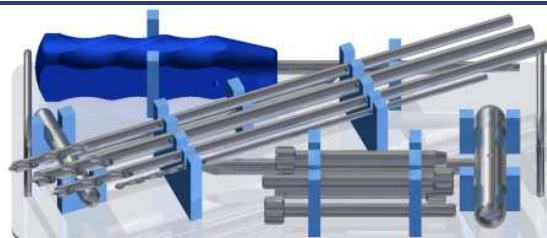

Paleta 2/ Tray 2

Nazwa/ Description	Kaseta sterylizacyjna/ Sterilization container	Nr katalogowy/ Cat No
Paleta 1 Tray 1	540016	540040
Paleta 2 Tray 2	540016	540041

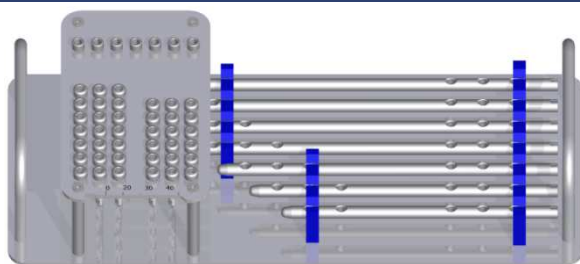

Paleta na gwoździe i wkręty (bez implantów)
Tray for nails and screws (without implants)

Dla gwoździ For nails	Kaseta sterylizacyjna/ Sterilization container	Nr katalogowy/ Cat No
Ø6,0	540016	540046
Ø7,0	540016	540047
Ø8,0	540016	540048



Trzpień kontrolny Ø3,0mm
Control pin Ø3,0mm

Nr katalogowy
Cat No

075196

GWOŹDZIE RYGLOWANE N-LOCK /
N-LOCK INTERLOCKING NAILS

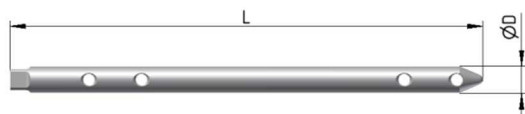

Gwoździe ryglowane N-Lock
N-Lock interlocking nails

L [mm]	Nr katalogowy Cat No		Nr katalogowy Cat No	
	ØD = 4 mm		ØD = 5 mm	
	SS	Ti	SS	Ti
70	031407	031407T	031507	031507T
80	031408	031408T	031508	031508T
90	031409	031409T	031509	031509T
100	031410	031410T	031510	031510T
110	031411	031411T	031511	031511T

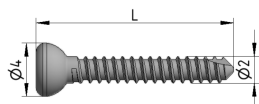

Wkręt ryglujący Ø2,0mm pełnogwintowany, samogwintujący
Locking screw Ø2,0mm, fully threaded, self-tapping

L [mm]	Nr katalogowy	
	SS	Ti
10	029910	029910T
12	029912	029912T
14	029914	029914T
16	029916	029916T
18	029918	029918T
20	029920	029920T
22	029922	029922T
24	029924	029924T

L [mm]	Nr katalogowy	
	SS	Ti
26	029926	029926T
28	029928	029928T
30	029930	029930T
32	029932	029932T
34	029934	029934T
36	029936	029936T
38	029938	029938T
40	029940	029940T



Wkręt zaślepiający M3
M3 End cap

Do gwoździ	Nr katalogowy Cat No	
	SS	Ti
Ø4 i Ø5	029050	029050T

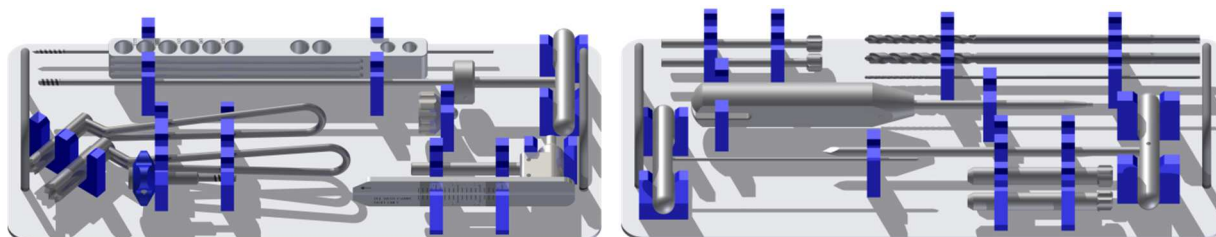
GWOŹDZIE WETERYNARYJNE Ø4 i Ø5 – ZESTAW INSTRUMENTÓW
VETERINARY NAILS – INSTRUMENTS SET

Lp.	Nazwa elementu / Description	Nr katalogowy Cat No	Ilość Pcs
1	Prowadnica do gwoździ weterynaryjnych – komplet Veterinary targeting device - set	075400	1
2	Trokar Ø1,5mm Trocar Ø1,5mm	079055	1
3	Trokar Ø4,0mm Trocar Ø4,0mm	079007	1
4	Wiertło Ø1,5mm Drill Ø1,5mm	711015	1
5	Wiertło Ø4,0mm Drill Ø4,0mm	071204	1
6	Wiertło Ø5,0mm Drill Ø5,0mm	071205	1
7	Wkrętak heksagonalny S2.0 Hexagonal screwdriver S2.0	781110	1
8	Tuleja wiertarska Ø1,5mm Drill sleeve Ø1,5mm	075197	2
9	Tuleja ochronna Ø4,0mm Protection sleeve Ø4,0mm	075198	2
10	Miarka długości wkrętów Length gauge for screws	770125	1
11	Tuleja wiertarska Ø4,0mm Protection sleeve Ø4,0mm	075064	1
12	Tuleja wiertarska Ø5,0mm Protection sleeve Ø5,0mm	075065	1
13	Drut Kirschnera M2x200mm Kirschner Wire M2x200mm	312004	2
14	Wybijak Extractor	075420	1
15	Paleta 1 Tray 1	540042	1
16	Paleta 2 Tray 2	540043	1
Elementy dodatkowe / Additional elements			
17	Paleta na gwoździe weterynaryjne Tray for veterinary nails	540049	Opcjonalnie Optional
18	Kaseta sterylizacyjna Sterilization container	540016	opcjonalnie optional

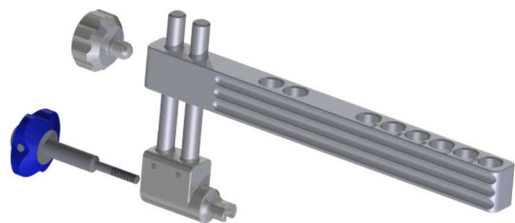

Prowadnica do gwoździ weterynaryjnych – komplet
Veterinary targeting device - set

Nr katalogowy
Cat No

075400



Trokar
Trocar

ØD [mm]	Nr katalogowy Cat No
Ø1,5	079055
Ø4,0	079007

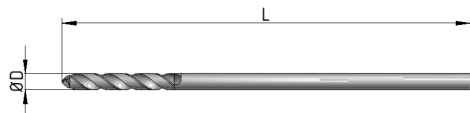

Wiertło
Drill

ØD [mm]	L [mm]	Nr katalogowy Cat No
Ø1,5	150	711515
Ø4,0	150	071204
Ø5,0	150	071205



Wkrętak heksagonalny S2,0 lity
Hexagonal screwdriver S2,0 solid

L [mm]	S [mm]	Nr katalogowy Cat No
120	2,0	781110



Tuleja wiertarska Ø1,5mm
Drill sleeve Ø1,5mm

Nr katalogowy
Cat No

075197



Tuleja ochronna Ø4,0mm
Protection sleeve Ø4,0mm

Nr katalogowy
Cat No

075198

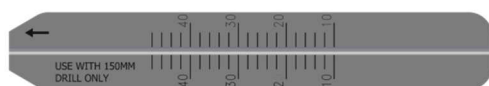

Miarka długości wkrętów
Length gauge for screws

Nr katalogowy
Cat No

770125

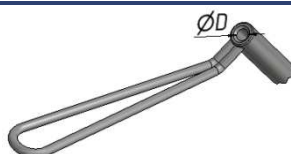

Tuleja ochronna
Protection sleeve

ØD [mm]	Nr katalogowy Cat No
4,0	075064
5,0	075065

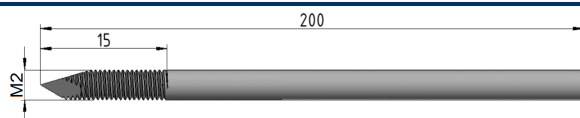

Drut Kirschnera M2x200mm
Kirschner Wire M2x200mm

Nr katalogowy
Cat No

312004



Wybijak
Extraktor

Nr katalogowy/ Cat No

075420

Palety sterylizacyjne do zestawu narzędzi do gwoździ weterynaryjnych (bez narzędzi)
Sterilization trays for set of instruments for veterinary nail (without instruments)

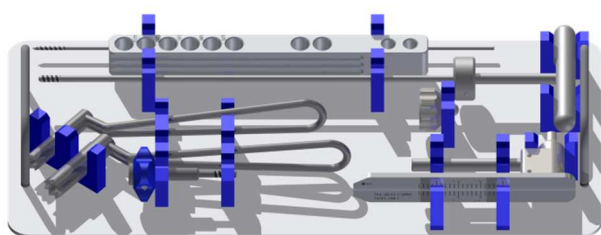

Paleta 1/ Tray 1

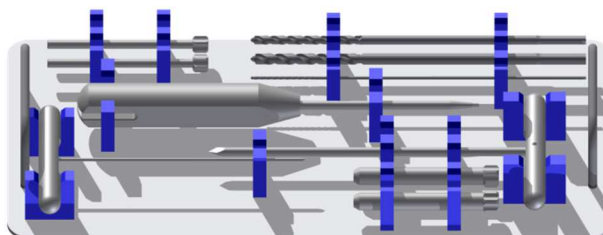

Paleta 2/ Tray 2

Nazwa/ Description	Kaseta sterylizacyjna/ Sterilization container	Nr katalogowy/ Cat No
Paleta 1 Tray 1	540016	540042
Paleta 2 Tray 2	540016	540043

Paleta na gwoździe i wkręty (bez implantów)
Tray for nails and screws (without implants)

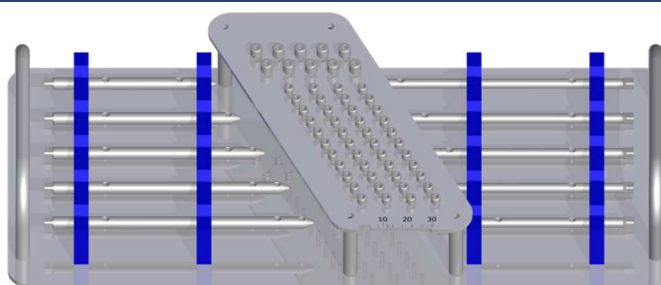

Dla gwoździ For nails	Kaseta sterylizacyjna/ Sterilization container	Nr katalogowy/ Cat No
Ø4,0 i Ø5,0	540016	540049



Trzpień kontrolny Ø1,5mm
Control pin Ø1,5mm

Nr katalogowy
Cat No

075199

TTA



Płytką TTA (1.0 mm grubości)
TTA plate (1.0 mm thickness)

L [mm]	Ilość otworów bliższych/dalszych No. holes proximal/distal	Zalecane wkręty [mm] Recommended screws [mm]	Nr katalogowy Cat No	
			SS	Ti
41	2 / 2	2,4 / 2,7	090436	090436T
51	2 / 2	2,4 / 2,7	090438	090438T
64	2 / 2	2,4 / 2,7	090440	090440T
77	3 / 2	2,4 / 3,5	090442	090442T
90	3 / 2	2,4 / 3,5	090444	090444T
107	3 / 2	2,4 / 3,5	090446	090446T

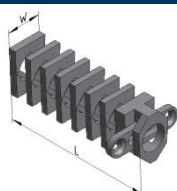

Kostka TTA z możliwością docinania długości
TTA cage with possibility to cut the length

W [mm]	L [mm]	Dla wkrętów [mm]* For screws [mm]*	Nr katalogowy Cat No	
			SS	Ti
6	26	Ø2,4	090420	090420T
7.5	26		090422	090422T
9	29	Ø2,7	090424	090424T
10.5	29		090426	090426T
12	32		090428	090428T
13.5	32		090430	090430T
15	35		090432	090432T
16	35		090434	090434T

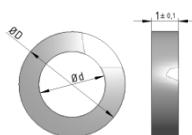

Podkładka dystansowa
Spacer

ØD [mm]	Ød [mm]	Dla kostki TTA For TTA cage	Nr katalogowy Cat No	
			SS	Ti
4,0	2,5	090420	029012	029012T
		090422		
5,0	2,8	090424	029014	029014T
		090426		
		090428		
		090430		
		090432		
090434				

*Asortyment wkrętów Ø2,4 Ø2,7 Ø3,5 dostępny na stronach 41-42.

*See Ø2,4 Ø2,7 Ø3,5 screws on pages 41-42.

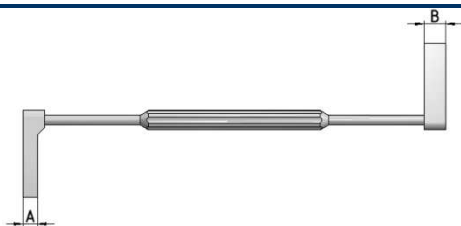
Rozpierak do kostek TTA
Spreader for TTA cages

A [mm]	B [mm]	Nr katalogowy Cat No
6	9	076015
12	16	076020

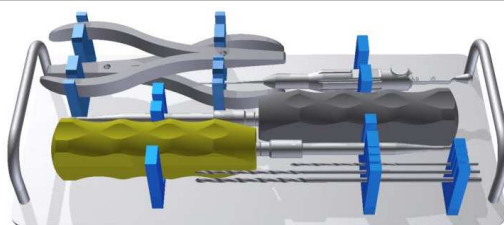
TTA – ZESTAW INSTRUMENTÓW
TTA – INSTRUMENTS SET

Lp.	Nazwa elementu / Description	Nr katalogowy Cat No	Ilość Pcs
1	Wyginak płytek drobnych Bending pliers for small plates	470020	2
2	Miarka głębokości L=50mm Depth gauge L=50mm	772030	1
3	Wkrętak heksagonalny S=2,0mm Hexagonal screwdriver S=2,0mm	781201	1
4	Wkrętak heksagonalny S=2,5mm Hexagonal screwdriver S=2,5mm	781200	1
5	Wiertło Ø1,5x100mm Drill Ø1,5x100mm	711015	1
6	Wiertło Ø2,0x150mm Drill Ø2,0x150mm	711020	1
7	Wiertło Ø2,5x150mm Drill Ø2,5x150mm	711025	1
9	Kleszcze do ucinania kostek TTA Forceps for TTA cages cutting	440010	1
8	Paleta na instrumentarium TTA Tray for TTA instruments	540032	1
Elementy dodatkowe / Additional elements			
9	Wkrętak dynamometryczny S2.0 Torque limiting screwdriver S2.0	783120	opcjonalnie optional
10	Wkrętak dynamometryczny S2.5 Torque limiting screwdriver S2.5	783125	opcjonalnie optional
11	Paleta na implanty TTA wraz ze statywem na wkręty Tray for TTA implants with stand for screws	540025	opcjonalnie optional
12	Kaseta sterylizacyjna Sterilization container	540016	opcjonalnie optional

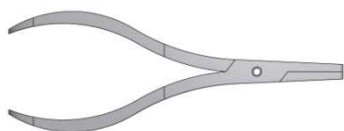

Wyginak do płytek drobnych
Bending pliers for small plates

Nr katalogowy
Cat No

470020



Miarka głębokości L=50mm
Depth gauge L=50mm

Nr katalogowy
Cat No

772030



Wkrętak heksagonalny
Hexagonal screwdriver

Ø wkręta Ø of screw	S [mm]	Nr katalogowy Cat No
2,4	2,0	781201
2,7-4,0	2,5	781200

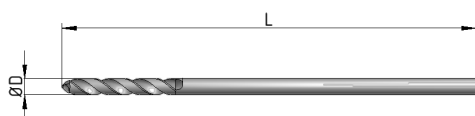

Wiertło
Drill

ØD [mm]	L [mm]	Nr katalogowy Cat No
Ø1,5	100	711015
Ø2,0	150	711020
Ø2,5	150	711025



Kleszcze do ucinania kostek TTA
Forceps for TTA cages cutting

Nr katalogowy
Cat No

440010

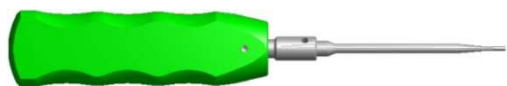

**Wkrętak dynamometryczny
Torque limiting screwdriver**

Ø wkręta Ø of screw	S [mm]	Nr katalogowy Cat No
2,4	2,0	783120
2,7-4,0	2,5	783125

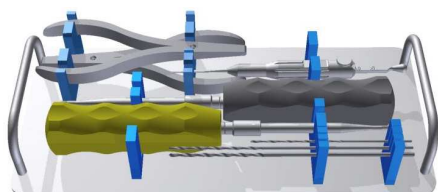

**Paleta na instrumentarium TTA (bez narzędzi)
Tray for TTA instruments (without instruments)**

Kaseta sterylizacyjna/ Sterilization container	Nr katalogowy Cat No
540016	540032

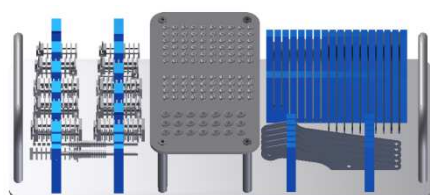

**Paleta na implanty TTA wraz ze statywem na wkręty (bez implantów)
Tray for TTA implants with stand for screws (without implants)**

Kaseta sterylizacyjna/ Sterilization container	Nr katalogowy Cat No
540016	540025

**WKRĘT DO DEKOMPRESJI KOŃSKIEGO OGONA U PSA
CAUDA EQUINA DECOMPRESSION SCREW**

**Wkręt do dekompresji końskiego ogona u psa Ø7,0
Cauda equina decompression screw Ø7,0**

L [mm]	Nr katalogowy Cat No
	Ti
80	024080T
90	024090T
100	024100T
110	024110T
120	024120T
130	024130T



**Wkręt do dekompresji końskiego ogona u psa Ø5,0
Cauda equina decompression screw Ø5,0**

L [mm]	Nr katalogowy Cat No
	Ti
50	024005T
60	024006T
70	024007T
80	024008T
90	024009T
100	024010T

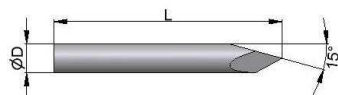

Prowadnik do wkrętów do dekompresji końskiego ogona u psa
Tap for cauda equina decompression screw

Opis		Nr katalogowy Catalogue No
Prowadnik centrujący - komplet		-
1.	Prowadnik centrujący - korpus	750720
2.	Tuleja Ø1,5	750706
3.	Tuleja Ø2,0	750703
4.	Tuleja Ø3,5	750708
5.	Tuleja Ø4,5	750701



Drut Kirschnera z ostrzem jednostronnym typu trokar
Kirschner wire with trocar tip

ØD [mm]	Nr katalogowy Cat No	
	L [mm]	
	150	230
1,5	311515	311523
2,0	312015	312023

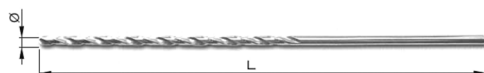

Wiertło kaniulowane
Cannulated drill

ØD[mm]	L[mm]	Dla wkręta For screws	Nr katalogowy Cat No
Ø3,5 / Ø1,7	180	Ø5,0	713235
Ø4,5 / Ø2,2	180	Ø7,0	713245

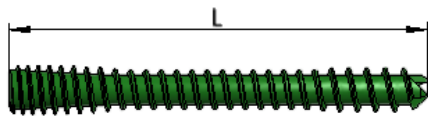
SYSTEM WKRĘTÓW KOMPRESYJNYCH/
COMPRESSION SCREW SYSTEM

Wkręt kompresyjny kaniulowany Ø2,5
Headless Conical Cannulated compression screw
Ø2,5

ØD [mm]	L [mm]	Nr katalogowy Catalogue No
Ø2,5	8	M-700.250.008.S
	10	M-700.250.010.S
	12	M-700.250.012.S
	14	M-700.250.014.S
	16	M-700.250.016.S
	18	M-700.250.018.S

ØD [mm]	L [mm]	Nr katalogowy Catalogue No
Ø2,5	20	M-700.250.020.S
	22	M-700.250.022.S
	24	M-700.250.024.S
	26	M-700.250.026.S
	28	M-700.250.028.S
	30	M-700.250.030.S

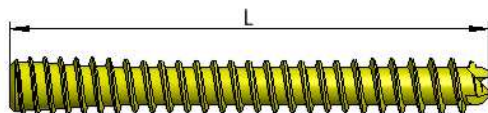

Wkręt kompresyjny kaniulowany Ø3,5
Headless Conical Cannulated compression screw
Ø3,5

ØD [mm]	L [mm]	Nr katalogowy Catalogue No
Ø3,5	16	M-700.350.016.S
	18	M-700.350.018.S
	20	M-700.350.020.S
	22	M-700.350.022.S
	24	M-700.350.024.S
	26	M-700.350.026.S
	28	M-700.350.028.S
	30	M-700.350.030.S

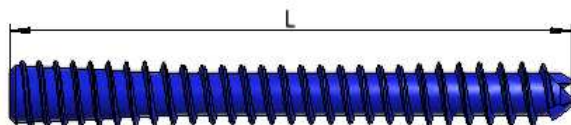

Wkręt kompresyjny kaniulowany Ø4,5
Headless Conical Cannulated compression screw
Ø4,5

ØD [mm]	L [mm]	Nr katalogowy Catalogue No
Ø4,5	20	M-700.450.020.S
	22	M-700.450.022.S
	24	M-700.450.024.S
	26	M-700.450.026.S
	28	M-700.450.028.S

ØD [mm]	L [mm]	Nr katalogowy Catalogue No
Ø4,5	30	M-700.450.030.S
	35	M-700.450.035.S
	40	M-700.450.040.S
	45	M-700.450.045.S
	50	M-700.450.050.S

SYSTEM PŁYTEK KOMPRESYJNO-BLOKOWANYCH/
LOCKING - COMPRESSION PLATE SYSTEM



Płytki blokowane, kompresyjna rekonstrukcyjna prosta 8,0x1,8mm
Reconstruction self-compressing locking plate 8,0x1,8mm

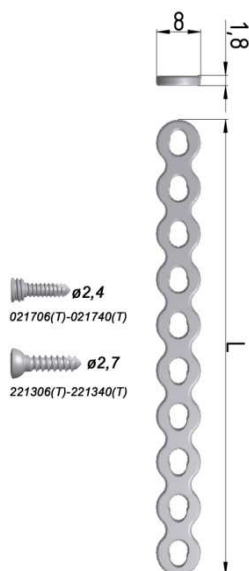

Ilość otworów No. holes	L [mm]	Nr katalogowy/ Cat No	
		SS	Ti
6	48	012176	012176T
7	56	012177	012177T
8	64	012178	012178T
9	72	012179	012179T
10	80	012180	012180T
11	88	012181	012181T
12	96	012182	012182T



Płytki blokowane, prosta 8x2,5mm
Straight locking plate 8,0x2,5mm

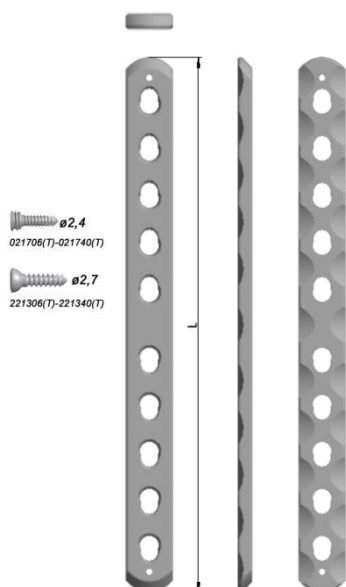

Ilość otworów No. holes	L [mm]	Nr katalogowy/ Cat No	
		SS	Ti
4	43	013854	013854T
6	59	013856	013856T
8	75	013858	013858T
10	91	013860	013860T
12	107	013862	013862T
14	123	013864	013864T
16	139	013866	013866T

3,5 SYSTEM
Mikromed Locking Plates

Płytki T blokowane pod wkręty SYSTEM 3,5
T locking plate for screws SYSTEM 3,5

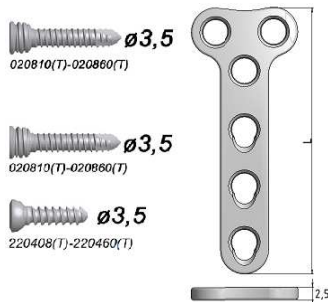

Ilość otworów No. holes	L [mm]	Nr katalogowy/ Cat No
		Ø of screw=3,5mm
2/4	54	012454
3/3	64	012464
2/5	76	012476
3/3	86	012486

3,5 SYSTEM
Mikromed Locking Plates

Płytki blokowane rekonstrukcyjna 9,0x2,2mm
Reconstruction locking plate 9,0x2,2mm

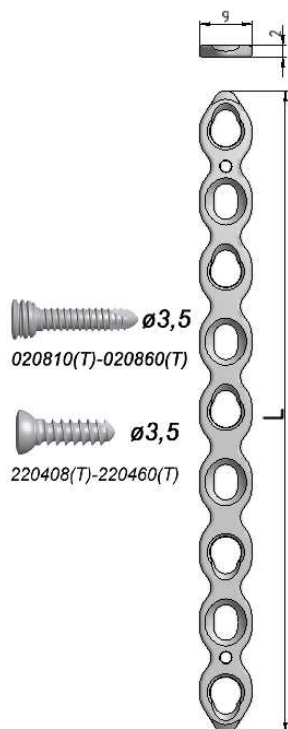

Ilość otworów No. holes	L [mm]	Nr katalogowy/ Cat No	
		SS	Ti
6	74	012032	012032T
7	86	012033	012033T
8	98	012034	012034T
9	110	012035	012035T
10	122	012036	012036T
11	134	012037	012037T
12	146	012038	012038T
13	158	012039	012039T

3,5 SYSTEM
Mikromed Locking Plates

Płytki blokowane rekonstrukcyjna 10,0x2,6
Reconstruction locking plate 10,0x2,6

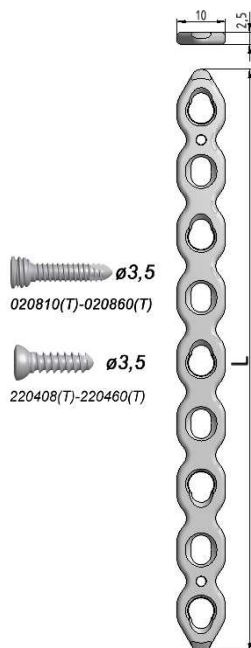

Ilość otworów No. holes	L [mm]	Nr katalogowy/ Cat No	
		SS	Ti
6	82	012052	012052T
7	95	012053	012053T
8	108	012054	012054T
9	121	012055	012055T
10	134	012056	012056T
11	147	012057	012057T
12	160	012058	012058T

3,5 SYSTEM
Mikromed Locking Plates

Płytki blokowane rekonstrukcyjna 11,0x3,0
Reconstruction locking plate 11,0x3,0

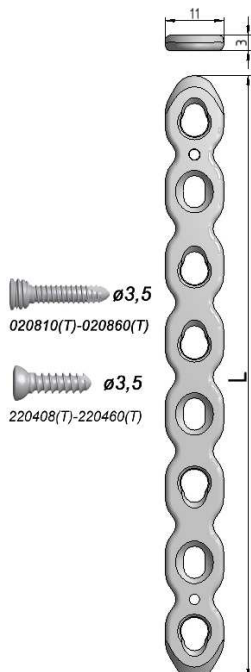

Ilość otworów No. holes	L [mm]	Nr katalogowy/ Cat No	
		SS	Ti
6	88	012072	012072T
7	102	012073	012073T
8	116	012074	012074T
9	130	012075	012075T
10	144	012076	012076T
11	158	012077	012077T
12	172	012078	012078T
13	186	012079	012079T

3,5 SYSTEM
Mikromed Locking Plates

Płytką blokowaną rekonstrukcyjną 10,2x3,2
Reconstruction locking plate 10,2x3,2

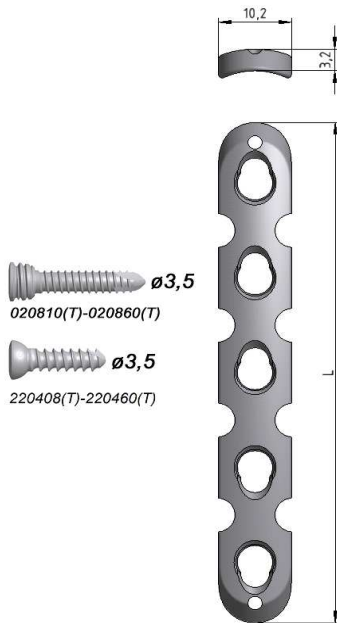

Ilość otworów No. holes	L [mm]	Nr katalogowy Cat No	
		Nr	SS
6	88	012256	
7	102	012257	
8	116	012258	
9	130	012259	
10	144	012260	

3,5 SYSTEM
Mikromed Locking Plates

Płytką blokowaną wąską 12x4,0
Narrow locking plate 12x4,0

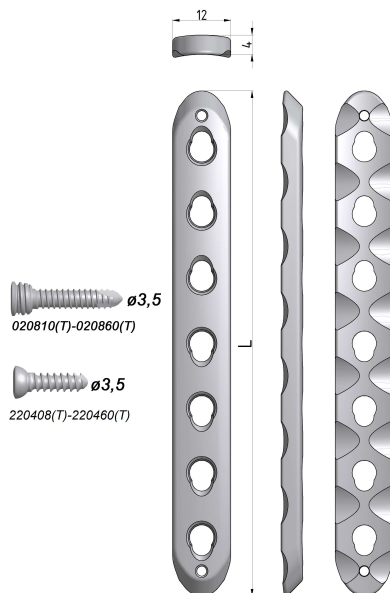

Ilość otworów No. holes	L [mm]	Nr katalogowy Cat No	
		SS	Ti
6	87	012106	012106T
7	102	012107	012107T
8	115	012108	012108T
9	128	012109	012109T
10	141	012110	012110T
11	154	012111	012111T
12	167	012112	012112T

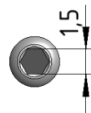
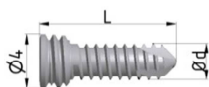

Wkręt blokujący $\phi 2,4$ i $\phi 2,7$
Locking screw $\phi 2,4$ and $\phi 2,7$

L [mm]	Nr katalogowy / Catalogue No			
	$\phi d=2,4\text{mm}$		$\phi d=2,7\text{mm}$	
	SS	Ti	SS	Ti
6	021706	021706T	021306	021306T
8	021708	021708T	021308	021308T
10	021710	021710T	021310	021310T
12	021712	021712T	021312	021312T
14	021714	021714T	021314	021314T
15	021715	021715T	021315	021315T
16	021716	021716T	021316	021316T
18	021718	021718T	021318	021318T
20	021720	021720T	021320	021320T
22	021722	021722T	021322	021322T
24	021724	021724T	021324	021324T
25	021725	021725T	021325	021325T
26	021726	021726T	021326	021326T
28	021728	021728T	021328	021328T
30	021730	021730T	021330	021330T
32	021732	021732T	021332	021332T
34	021734	021734T	021334	021334T
35	021735	021735T	021335	021335T
36	021736	021736T	021336	021336T
38	021738	021738T	021338	021338T
40	021740	021740T	021340	021340T



Gniazdo T8



Wkręt blokujący $\phi 2,4$ i $\phi 2,7$
Locking screw $\phi 2,4$ and $\phi 2,7$

L [mm]	Nr katalogowy / Catalogue No			
	$\phi d=2,4\text{mm}$		$\phi d=2,7\text{mm}$	
	SS	Ti	SS	Ti
6	061706	061706T	061306	061306T
8	061708	061708T	061308	061308T
10	061710	061710T	061310	061310T
12	061712	061712T	061312	061312T
14	061714	061714T	061314	061314T
15	061715	061715T	061315	061315T
16	061716	061716T	061316	061316T
18	061718	061718T	061318	061318T
20	061720	061720T	061320	061320T
22	061722	061722T	061322	061322T
24	061724	061724T	061324	061324T
25	061725	061725T	061325	061325T
26	061726	061726T	061326	061326T
28	061728	061728T	061328	061328T
30	061730	061730T	061330	061330T
32	061732	061732T	061332	061332T
34	061734	061734T	061334	061334T
35	061735	061735T	061335	061335T
36	061736	061736T	061336	061336T
38	061738	061738T	061338	061338T
40	061740	061740T	061340	061340T

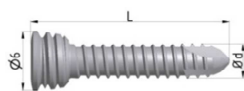

Wkręt blokujący $\varnothing 2,7$; $\varnothing 3,5$ i $\varnothing 4,0$
 Locking screw $\varnothing 2,7$; $\varnothing 3,5$ and $\varnothing 4,0$

L [mm]	Nr katalogowy / Catalogue No					
	$\varnothing d=2,7\text{mm}$		$\varnothing d=3,5\text{mm}$		$\varnothing d=4,0\text{mm}$	
	SS	Ti	SS	Ti	SS	Ti
10	021510	021510T	020810	020810T		
12	021512	021512T	020812	020812T		
14	021514	021514T	020814	020814T		
15	021515	021515T	020815	020815T		
16	021516	021516T	020816	020816T		
18	021518	021518T	020818	020818T		
20	021520	021520T	020820	020820T		
22	021522	021522T	020822	020822T	021922	021922T
24	021524	021524T	020824	020824T	021924	021924T
25	021525	021525T	020825	020825T	021925	021925T
26	021526	021526T	020826	020826T	021926	021926T
28	021528	021528T	020828	020828T	021928	021928T
30	021530	021530T	020830	020830T	021930	021930T
32	021532	021532T	020832	020832T	021932	021932T
34	021534	021534T	020834	020834T	021934	021934T
35	021535	021535T	020835	020835T	021935	021935T
36	021536	021536T	020836	020836T	021936	021936T
38	021538	021538T	020838	020838T	021938	021938T
40	021540	021540T	020840	020840T	021940	021940T
42			020842	020842T	021942	021942T
44			020844	020844T	021944	021944T
45			020845	020845T	021945	021945T
46			020846	020846T	021946	021946T
48			020848	020848T	021948	021948T
50			020850	020850T	021950	021950T
52			020852	020852T	021952	021952T
54			020854	020854T	021954	021954T
55			020855	020855T	021955	021955T
56			020856	020856T	021956	021956T
58			020858	020858T	021958	021958T
60			020860	020860T	021960	021960T



Gniazdo T15



Wkręt blokujący $\varnothing 2,7$; $\varnothing 3,5$ i $\varnothing 4,0$
Locking screw $\varnothing 2,7$; $\varnothing 3,5$ and $\varnothing 4,0$

L [mm]	Nr katalogowy / Catalogue No					
	$\varnothing d=2,7\text{mm}$		$\varnothing d=3,5\text{mm}$		$\varnothing d=4,0\text{mm}$	
	SS	Ti	SS	Ti	SS	Ti
10	061510	061510T	060810	060810T		
12	061512	061512T	060812	060812T		
14	061514	061514T	060814	060814T		
15	061515	061515T	060815	060815T		
16	061516	061516T	060816	060816T		
18	061518	061518T	060818	060818T		
20	061520	061520T	060820	060820T		
22	061522	061522T	060822	060822T	061922	061922T
24	061524	061524T	060824	060824T	061924	061924T
25	061525	061525T	060825	060825T	061925	061925T
26	061526	061526T	060826	060826T	061926	061926T
28	061528	061528T	060828	060828T	061928	061928T
30	061530	061530T	060830	060830T	061930	061930T
32	061532	061532T	060832	060832T	061932	061932T
34	061534	061534T	060834	060834T	061934	061934T
35	061535	061535T	060835	060835T	061935	061935T
36	061536	061536T	060836	060836T	061936	061936T
38	061538	061538T	060838	060838T	061938	061938T
40	061540	061540T	060840	060810T	061940	061940T
42			060842	060840T	061942	061942T
44			060844	060842T	061944	061944T
45			060845	060844T	061945	061945T
46			060846	060845T	061946	061946T
48			060848	060846T	061948	061948T
50			060850	060848T	061950	061950T
52			060852	060850T	061952	061952T
54			060854	060852T	061954	061954T
55			060855	060854T	061955	061955T
56			060856	060855T	061956	061956T
58			060858	060856T	061958	061958T
60			060860	060858T	061960	061960T

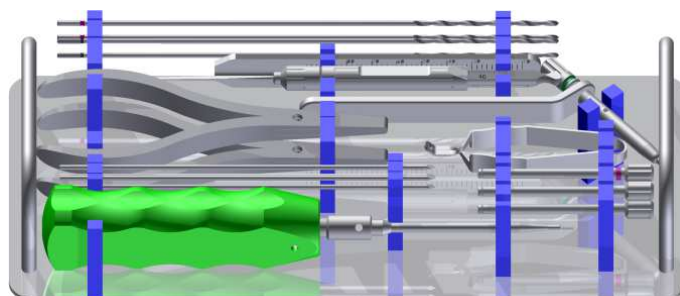
871021 – ZESTAW INSTRUMENTÓW SYSTEM 2,4
871021 – SET OF INSTRUMENTS 2,4 SYSTEM

Lp.	Nazwa elementu/ Description	Nr katalogowy Cat No	Ilość Quantity
1	Prowadnik wiertła Ø2,0mm dla wkrętów blokujących Ø2,4 SYSTEM 2,4 Drill guide Ø2,0mm for locking screw Ø2,4mm SYSTEM 2,4	075055	2
2	Prowadnik wiertła Ø2,2mm dla wkrętów blokujących Ø2,7 SYSTEM 2,4 Drill guide Ø2,2mm for locking screw Ø2,7mm SYSTEM 2,4	075056	2
3	Prowadnica kompresyjna Ø2,0mm Compression guide Ø2,0mm	750014	1
4	Wiertło Ø2,0x200mm Drill Ø2,0x200mm	712120	2
5	Wiertło Ø2,2x200mm Drill Ø2,2x200mm	712122	2
6	Miarka długości wkrętów Length gauge for locking screw	770110	1
7	Miarka głębokości Depth gauge	771020	1
8	Wkrętak dynamometryczny S1,5, 0,8Nm Torque limiting screwdriver S1,5 0,8Nm	783115	1
9	Drut Kirschnera Ø1,0/M1; L-150/5mm Kirschner wire Ø1,0/M1; L-150/5mm	311000	2
10	Drut Kirschnera Ø1,0mm; L-150mm Kirschner wire Ø1,0mm; L-150mm	311015	2
11	Wyginak płytek drobnych Bending pliers for small bones	470020	2
12	Szczypce Forceps	470001	1
13	Paleta Tray	540021	1
Elementy dodatkowe / Additional elements			
14	Kaseta sterylizacyjna Sterilisation container	540016	opcjonalnie optional
15	Paleta na wkręty SYSTEM 2,4 Tray for screws SYSTEM 2,4	540026	opcjonalnie optional

3,5 SYSTEM
Mikromed Locking Plates

871022 – ZESTAW INSTRUMENTÓW SYSTEM 3,5
871022 – SET OF INSTRUMENTS 3,5 SYSTEM

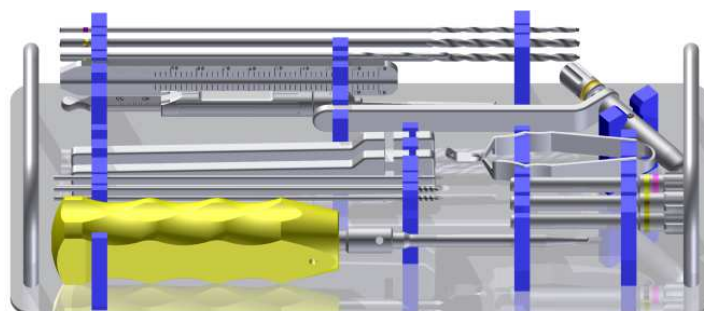

Lp.	Nazwa elementu / Description	Nr katalogowy Cat No	Ilość Quantity
1	Prowadnik wiertła Ø2,2mm dla wkrętów blokujących Ø2,7mm SYSTEM 3,5 Drill guide Ø2,2mm for locking screw Ø2,7mm SYSTEM 3,5	075057	2
2	Prowadnik wiertła Ø3,0mm dla wkrętów blokujących Ø3,5mm SYSTEM 3,5 Drill guide Ø3,0mm for locking screw Ø3,5mm SYSTEM 3,5	075060	2
3	Prowadnica kompresyjna Ø2,5mm Compression guide Ø2,5mm	750015	1
4	Wiertło Ø2,2x200mm Drill Ø2,2x200mm	712122	2
5	Wiertło Ø3,0x200mm Drill Ø3,0x200mm	712130	2
6	Wiertło Ø2,5x150mm Drill Ø2,5x150mm	711025	1
7	Miarka długości wkrętów Length gauge for screw	770110	1
8	Miarka głębokości Depth gauge	771020	1
9	Wkrętak dynamometryczny S2,5, 1,5Nm Torque limiting screwdriver S2,5 1,5Nm	783125	1
10	Drut Kirschnera Ø2,0/M2; L-150/15mm Kirschner wire Ø2,0/M2; L-150/15mm	312001	2
11	Drut Kirschnera Ø2,0; L-150mm Kirschner wire Ø2,0; L-150mm	312015	2
12	Wyginak płytek 2,7/3,5mm Bending iron for plates 2,7/3,5mm	790534	2
13	Szczypce Forceps	470001	1
14	Paleta Tray	540022	1
Elementy dodatkowe / Additional elements			
15	Kaseta sterylizacyjna Sterilisation container	540016	opcjonalnie optional
16	Paleta na wkręty SYSTEM 3,5 Tray for screws SYSTEM 3,5	540028	opcjonalnie optional

 Prowadnik wiertła dla wkrętów blokowanych
 Drill guide for locking screw

Prowadnik wiertła Drill guide	SYSTEM	Dla wkrętów For screws	Wiertło Drill	Nr katalogowy Cat No
	2,4 SYSTEM <i>Mikromed Locking Plates</i>	Ø2,4	Ø2,0	075055
		Ø2,7	Ø2,2	075056
	3,5 SYSTEM <i>Mikromed Locking Plates</i>	Ø2,7	Ø2,2	075057
		Ø3,5	Ø3,0	075060

 Prowadnica kompresyjna
 Compression guide

SYSTEM	Dla wkrętów standardowych For standard screws	Wiertło Drill	Nr katalogowy Cat No
2,4 SYSTEM <i>Mikromed Locking Plates</i>	Ø2,7	Ø2,0	750014
3,5 SYSTEM <i>Mikromed Locking Plates</i>	Ø3,5	Ø2,5	750015

 Wiertło dla wkrętów blokowanych
 Drill for locking screws

ØD[mm]	Kolor Colour	Dla wkrętów For screws	Nr katalogowy Cat No
Ø2,0	zielony green	2,4 SYSTEM <i>Mikromed Locking Plates</i>	712120
Ø2,2	magenta	2,4 SYSTEM <i>Mikromed Locking Plates</i> 3,5 SYSTEM <i>Mikromed Locking Plates</i>	712122
Ø3,0	żółty yellow	3,5 SYSTEM <i>Mikromed Locking Plates</i>	712130

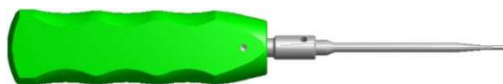

 Wiertło dla wkrętów standardowych
 Drill for standard screws

ØD[mm]	Dla wkrętów standardowych For standard screws	Nr katalogowy Cat No
Ø2,5	Ø3,5	711025

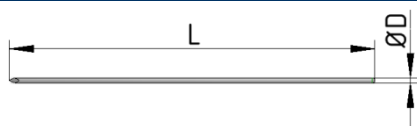

Wkrętak dynamometryczny
Torque Limiting Screwdriver

Dla wkrętów For screws	S	F [Nm]	Nr katalogowy Cat No
2,4 SYSTEM Mikromed Locking Plates	1,5	0,7	783115
3,5 SYSTEM Mikromed Locking Plates	2,5	1,5	783125



Drut Kirschnera
Kirschner wire

SYSTEM	ØD[mm]	L [mm]	Nr katalogowy Cat No
2,4 SYSTEM Mikromed Locking Plates	Ø1,0/M1	150	311000
	Ø1,0	150	311015
3,5 SYSTEM Mikromed Locking Plates	Ø2,0/M2	150	312001
	Ø2,0	150	312015



Miarka głębokości
Depth gauge

SYSTEM	Zakres pomiarowy Measuring range	Nr katalogowy Cat No
2,4 SYSTEM Mikromed Locking Plates	0 – 50	771020
3,5 SYSTEM Mikromed Locking Plates		



Wyginak płytek 2,7mm/3,5mm
Bending iron for plates 2,7/3,5mm

Nr katalogowy/ Cat No

790534

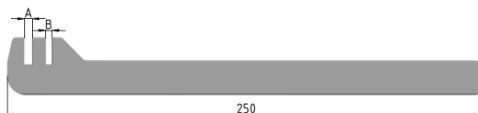
Wyginak płytek 3,5mm/4,2mm
Bending iron for plates 3,5mm/4,2mm

A [mm]	B [mm]	Nr katalogowy Catalog no.
4,2	3,5	790532
3,5	4,2	790547

Do wyginania płytek rekonstrukcyjnych o przekroju prostym rekomendujemy wyginaki zawarte w zestawie narzędzi (nr kat. 790534), natomiast do wyginania płytek o przekroju kształtowym zalecamy użycie wyginaków o nr. kat. 790532 lub 790547.

To bend reconstruction plates with straight profile we recommend the bending iron which is part of instruments set (cat. no 790534), whereas to bend plates with arched-shaped profile we recommend to use the bending iron with a cat. no 790532 or 790547.

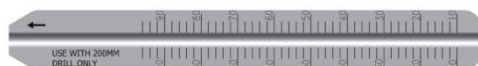
Miarka długości wkrętów blokujących
Length gauge for locking screw
Nr katalogowy Cat No

770110

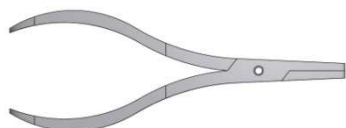
Wyginak do płytek drobnych
Bending pliers for small plates
Nr katalogowy/ Cat No

470020

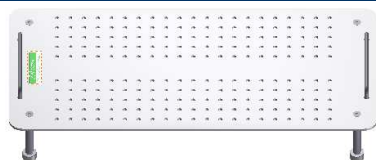

Pinceta do wkrętów drobnych
Forceps
Nr katalogowy/ Cat No

470001

Paleta na wkręty
Tray for screws

SYSTEM	Kaseta sterylizacyjna/ Sterilization container	Nr katalogowy/ Cat No
2,4 SYSTEM <i>Mikromed Locking Plates</i>	540015	540026
3,5 SYSTEM <i>Mikromed Locking Plates</i>	540015	540028

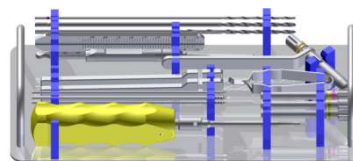
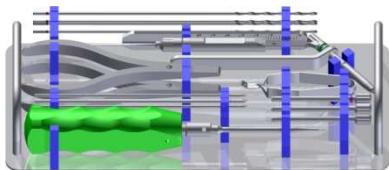
Palety sterylizacyjne do zestawu instrumentarium (bez narzędzi)
Sterilization trays for set of instruments (without instruments)



SYSTEM	Kaseta sterylizacyjna/ Sterilization container	Nr katalogowy/ Cat No
2,4 SYSTEM <i>Mikromed Locking Plates</i>	540016	540021
3,5 SYSTEM <i>Mikromed Locking Plates</i>	540016	540022

PŁYTKI PROSTE/ STRAIGHT PLATES

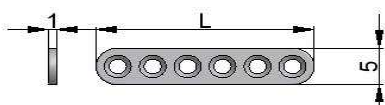

Płytką drobna 5,0x1,0mm pod wkręty \varnothing 1,5mm
Small plate 5,0x1,0mm for screws \varnothing 1,5mm

Ilość otworów No. holes	L [mm]	Nr katalogowy/ Cat No
2	9	111102
3	13	111103
4	17	111104
5	21	111105
6	25	111106
7	29	111107
8	33	111108
9	37	111109
10	41	111110

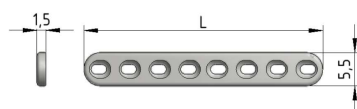

Płytką prostą 5,5x1,5mm pod wkręty \varnothing 1,5mm
Small plate 5,5 x1,5mm for screws \varnothing 1,5mm

Ilość otworów No. holes	L [mm]	Nr katalogowy/ Cat No
4	20	111300
5	25	111301
6	30	111302
7	35	111303
8	40	111304

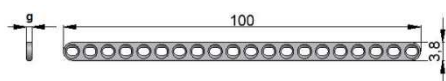

Płytką drobna 3,8 20 otworów pod wkręty \varnothing 1,5mm
Small plate 3,8 20 holes for screws \varnothing 1,5mm

g [mm]	Nr katalogowy/ Cat No
1,0	111150
1,5	111151

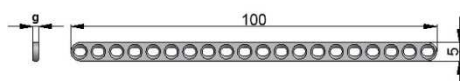

Płytką drobna 5,0 20 otworów pod wkręty \varnothing 2,0mm
Small plate 5,0 20 holes for screws \varnothing 2,0mm

g [mm]	Nr katalogowy/ Cat No
1,5	111200
2,0	111201

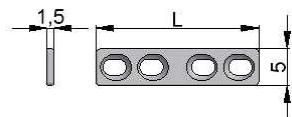

Płytką drobna samodociskowa 5,0x1,5mm dla wkrętów \varnothing 2,0mm
Small plate self-compressing 5,0 x 1,5mm for screws \varnothing 2,0mm

Ilość otworów No. holes	L[mm]	Nr katalogowy/ Cat No
2	17	122102
3	22	122103
4	27	122104
5	32	122105
6	37	122106
7	42	122107
8	47	122108
9	52	122109
10	57	122110
12	67	122112
14	77	122114
16	87	122116

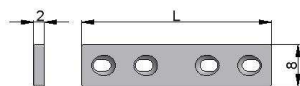

Płytką drobna 8,0x2,0mm samodociskowa pod wkręty \varnothing 2,0mm
Small plate 8,0x2,0mm self-compressing for screws \varnothing 2,0mm

Ilość otworów No. holes	L [mm]	Nr katalogowy/ Cat No
2	20	122202
4	36	122204
6	52	122206
8	68	122208
10	84	122210
12	100	122212
14	116	122214
16	132	122216

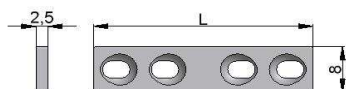

Płytką drobna 8,0 x 2,5mm samodociskowa pod wkręty \varnothing 2,7mm
Small plate 8,0 x 2,5mm self-compressing for screws \varnothing 2,7mm

Ilość otworów No. holes	L [mm]	Nr katalogowy/ Cat No
7	60	123207
8	68	123208
9	76	123209
10	84	123210
12	100	123212

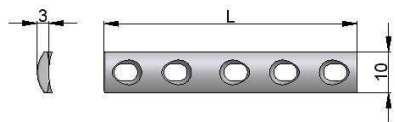

Płytką drobna 10,0x3,0mm samo dociskowa
 pod wkręty $\varnothing 3,5\text{mm}$ i $\varnothing 4,0\text{mm}$
 Small plate 10,0x3,0mm self-compressing
 for screws $\varnothing 3,5\text{mm}$ and $\varnothing 4,0\text{mm}$

Ilość otworów No. holes	L [mm]	Nr katalogowy/ Cat No
2	26	125402
3	38	125403
4	50	125404
5	62	125405
6	74	125406
7	86	125407
8	98	125408
10	122	125410
12	146	125412

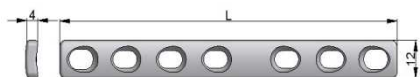

Płytką wąską samodociskowa 12,0x4,0mm
 z ograniczonym kontaktem pod wkręty $\varnothing 4,5\text{mm}$
 Narrow plate self-compressing 12,0x4,0mm limited contact
 for screws $\varnothing 4,5\text{mm}$

Ilość otworów No. holes	L [mm]	Nr katalogowy/Cat No
2	39	120302
3	55	120303
4	71	120304
5	87	120305
6	103	120306
7	119	120307
8	135	120308
9	151	120309
10	167	120310

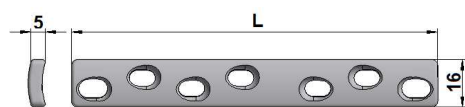

Płytką szeroką samodociskowa 16,0x5,0mm z ograniczonym
 kontaktem pod wkręty $\varnothing 4,5\text{mm}$
 Wide plate self-compressing 16,0x5,0mm limited contact
 for screws $\varnothing 4,5\text{mm}$

Ilość otworów No. holes	L [mm]	Nr katalogowy/ Cat No
4	71	121304
5	87	121305
6	103	121306
7	119	121307
8	135	121308
9	151	121309
10	167	121310

PŁYTKI KSZTAŁTOWE / SHAPED PLATES

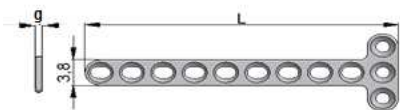

Płytki T – 3,8 pod wkręty Ø1,5mm
T plate – 3,8 for screws Ø1,5mm

	Ilość otworów No. holes	L [mm]	g [mm]	Nr katalogowy/ Cat No
	3/9	49	1,0	198193
	4/9			198194
	2/9			198195
	2/8	44	1,5	198196
			1,0	198197
			1,5	198199

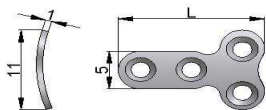

Płytki T – mini pod wkręty Ø1,5mm
T plate – mini for screws Ø1,5mm

	Ilość otworów No. holes	L [mm]	Nr katalogowy/ Cat No
	2/1	11	197153
	2/2	17	197154
	2/3	23	197155
	2/4	29	197156
	2/5	35	197177
	2/6	41	197178
	2/7	47	197179
	2/8	53	197180

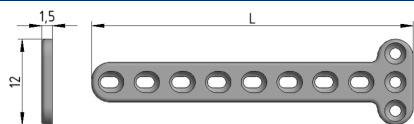

Płytki T pod wkręty $\varnothing 1,5\text{mm}$
T plate for screws $\varnothing 1,5\text{mm}$

L [mm]	Ilość otworów No. holes	Nr katalogowy/ Cat No
20	4	111310
25	5	111311
30	6	111312
35	7	111313
40	8	111314

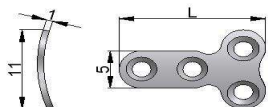

Płytki T – mini pod wkręty $\varnothing 2,0\text{mm}$
T plate – mini for screws $\varnothing 2,0\text{mm}$

	Ilość otworów No. holes	L [mm]	Nr katalogowy/ Cat No
	2/1	11	197149
	2/2	17	197150
	2/3	23	197151
	2/4	29	197152
	2/5	35	197167
	2/6	41	197168
	2/7	47	197169
	2/8	53	197170

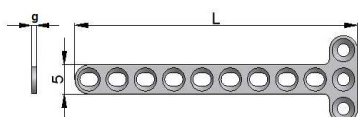

Płytki T – 5,0 pod wkręty $\varnothing 2,0\text{mm}$
T plate – 5,0 for screws $\varnothing 2,0\text{mm}$

	Ilość otworów No. holes	L [mm]	g [mm]	Nr katalogowy/ Cat No
	3/9	50	1,2	198093
	4/9			198094
	2/9	45	1,5	198095
	2/9		2,0	198096
	2/8	45	1,5	198097
	2/8		2,0	198099

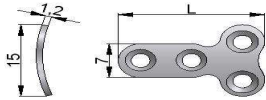

Płytki T – mini pod wkręty $\varnothing 2,7\text{mm}$
T plate – mini for screws $\varnothing 2,7\text{mm}$

	Ilość otworów No. holes	L [mm]	Nr katalogowy/ Cat No
	2/1	15	197138
	2/2	23	197139
	2/3	31	197140
	2/4	39	197141

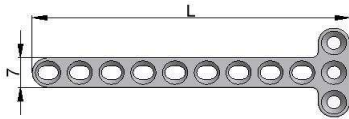

Płytki T – 7,0x1,5mm pod wkręty $\varnothing 2,7\text{mm}$
T plate – 7,0x1,5mm for screws $\varnothing 2,7\text{mm}$

	Ilość otworów No. holes	L [mm]	Nr katalogowy Cat No
	3/9	80	198293
	4/9		198294

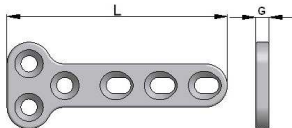

Płytki T pod wkręty $\varnothing 2,0\text{mm}$, $\varnothing 2,7\text{mm}$, $\varnothing 3,5\text{mm}$ i $\varnothing 4,5\text{mm}$
T plate for screws $\varnothing 2,0\text{mm}$, $\varnothing 2,7\text{mm}$, $\varnothing 3,5\text{mm}$ and $\varnothing 4,5\text{mm}$

L [mm]	G [mm]	Ilość otworów No. holes	Nr katalogowy Cat No			
			Wkręty/ Screws $\varnothing 2,0\text{mm}$	Wkręty/ Screws $\varnothing 2,7\text{mm}$	Wkręty/ Screws $\varnothing 3,5\text{mm}$	Wkręty/ Screws $\varnothing 4,5\text{mm}$
35	1,5	3/3	012520	-	-	-
43		3/4	012524	-	-	-
40	2,5	3/3	-	012540	-	-
48		3/4	-	012544	-	-
55		3/3	-	-	012554	-
76		3/4	-	-	012576	-
55	4,0	3/3	-	-	012564	-
76		3/4	-	-	012586	-
77	4,5	3/3	-	-	-	012580
90		3/4	-	-	-	012590



Płytkę do miednicy pod wkręty $\varnothing 2,0 - 3,5\text{mm}$
 Plate for pelvis for screws $\varnothing 2,0 - 3,5\text{mm}$

L [mm]	Wymiar/ Dimension S x G [mm]	Ilość otworów No. holes	Nr katalogowy Cat No		
			Wkręty/ Screws $\varnothing 2,0\text{mm}$	Wkręty/ Screws $\varnothing 2,7\text{mm}$	Wkręty/ Screws $\varnothing 3,5\text{mm}$
18	3,5 x 1,5	4	010435	-	-
32	5,5 x 2,0	6	-	010455	-
35	6,0 x 2,0	6	-	010460	-
41	6,5 x 2,5	6	-	-	010465
45	8,0 x 2,5	6	-	-	010480

PŁYTKI REKONSTRUKCYJNE / RECONSTRUCTION PLATES

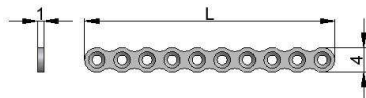

Płytki rekonstrukcyjna 4,0x1,0mm mikro pod wkręty \varnothing 1,5mm
Reconstruction plate 4,0x1,0mm micro for screws \varnothing 1,5mm

Ilość otworów No. holes	L [mm]	Nr katalogowy Cat No
4	16	010062
6	24	010064
8	32	010066
10	40	010068
12	48	010070



Płytki rekonstrukcyjna 5,0x1,0mm pod wkręty \varnothing 2,0mm
Reconstruction plate 5,0x1,0mm for screws \varnothing 2,0mm

Ilość otworów No. holes	L [mm]	Nr katalogowy Cat No
6	31	010026
7	36	010027
8	41	010028
10	51	010030
12	61	010032
14	71	010034
16	81	010036



Płytki rekonstrukcyjna 8,0x2,0mm pod wkręty \varnothing 2,7mm
Reconstruction plate 8,0x2,0mm for screws \varnothing 2,7mm

Ilość otworów No. holes	L [mm]	Nr katalogowy Cat No
4	32	010094
5	40	010095
6	48	010096
8	64	010098
10	80	010100



Płytki rekonstrukcyjna 10,0x2,0mm
 pod wkręty $\varnothing 3,5\text{mm}$ i $\varnothing 4,0\text{mm}$
Reconstruction plate 10,0x2,0mm
 for screws $\varnothing 3,5\text{mm}$ and $\varnothing 4,0\text{mm}$

Ilość otworów No. holes	L [mm]	Nr katalogowy Cat No
4	46	010042
5	58	010043
6	70	010044
8	94	010046
10	118	010048

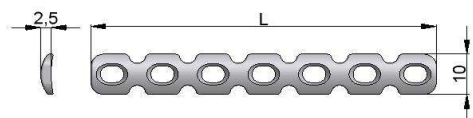

Płytki rekonstrukcyjna 10,0x2,5mm prosta
 pod wkręty $\varnothing 3,5\text{mm}$ i $\varnothing 4,0\text{mm}$
Reconstruction plate 10,0x2,5mm straight
 for screws $\varnothing 3,5\text{mm}$ and $\varnothing 4,0\text{mm}$

Ilość otworów No. holes	L [mm]	Nr katalogowy Cat No
5	58	010005
6	70	010006
7	82	010007
8	94	010008
9	106	010009
10	118	010010

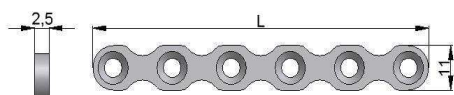

Płytki rekonstrukcyjna cienka
 pod wkręty $\varnothing 3,5\text{mm}$ i $\varnothing 4,0\text{mm}$
Reconstruction thin plate
 for screws $\varnothing 3,5\text{mm}$ and $\varnothing 4,0\text{mm}$

Ilość otworów No. holes	L [mm]	Nr katalogowy Cat No
6	91	166006
7	107	166007
8	123	166008
9	139	166009
10	155	166010

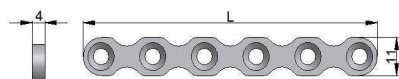

Płytki rekonstrukcyjna pod wkręty $\varnothing 4,5\text{mm}$
Reconstruction plate for screws $\varnothing 4,5\text{mm}$

Ilość otworów No. holes	L [mm]	Nr katalogowy Cat No
6	91	160106
7	107	160107
8	123	160108
10	155	160110

PŁYTKA SIATKOWA/ MESH PLATE

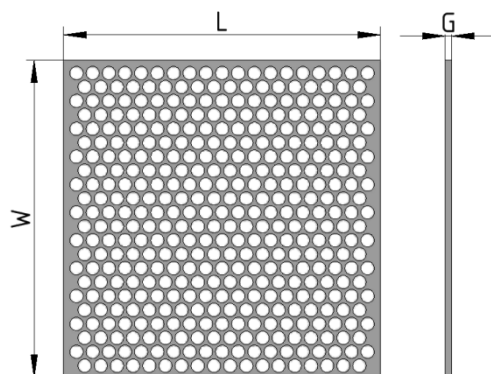

L x W [mm]	G [mm]	Zalecane wkręty Recommended screws	Nr katalogowy Cat No
			Ti
49 x 49	0,5	Ø2,0mm	019101T
	1,0		019111T
70 x 70	0,5	Ø2,4 - Ø 2,7mm	019102T
	1,0		019112T
90 x 90	0,5	Ø2,4 - Ø 2,7mm	019103T
	1,0		019113T

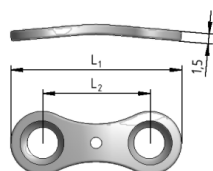
PŁYTKA DO KOREKЦИИ НАСАД КОЩИ ПИЩЕЛОВОЙ В ФАЗЕ ВЗРОСТУ/
PLATE FOR CORRECTION OF TIBIA EPIPHYSIS IN THE GROWTH PHASE



Płytki do korekcji nasad kości piszczelowych w fazie wzrostu
Plate for correction of tibia epiphysis in the growth phase

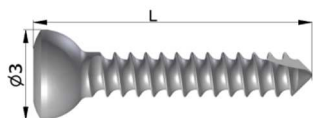

Dł. wkrętów For screws	L ₁ [mm]	L ₂ [mm]	Nr katalogowy/ Cat No
Ø4,5	21	12	010572T
	25	16	010576T

WKRETY / SCREWS





Wkręt do kości drobnych Ø1,5/1,0mm
Screw for small bones Ø1,5/1,0mm

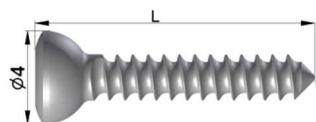

L [mm]	Nr katalogowy / Catalogue No			
				
	SS	T	SS	T
8	623208	623208T	623108	623108T
9	623209	623209T	623109	623109T
10	623210	623210T	623110	623110T
11	623211	623211T	623111	623111T
12	623212	623212T	623112	623112T

L [mm]	Nr katalogowy / Catalogue No			
				
	SS	T	SS	T
13	623213	623213T	623113	623113T
14	623214	623214T	623114	623114T
15	623215	623215T	623115	623115T
16	623216	623216T	623116	623116T





Wkręt do kości drobnych Ø2,0/1,3mm
Small bone screw Ø2,0/1,3mm

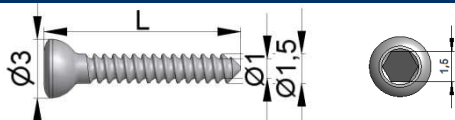

L [mm]	Nr katalogowy / Catalogue No			
				
	SS	T	SS	T
8	622208	622208T	622308	622308T
9	622209	622209T	622309	622309T
10	622210	622210T	622310	622310T
11	622211	622211T	622311	622311T
12	622212	622212T	622312	622312T
13	622213	622213T	622313	622313T
14	622214	622214T	622314	622314T
15	622215	622215T	622315	622315T
16	622216	622216T	622316	622316T

L [mm]	Nr katalogowy / Catalogue No			
				
	SS	T	SS	T
17	622217	622217T	622317	622317T
18	622218	622218T	622318	622318T
19	622219	622219T	622319	622319T
20	622220	622220T	622320	622320T
21	622221	622221T	622322	622322T
22	622222	622222T	622323	622323T
23	622223	622223T	622324	622324T
24	622224	622224T	622325	622325T
25	622225	622225T	622322	622322T





Wkręt do kości drobnych Ø1,5/1,0mm
Screw for small bones Ø1,5/1,0mm

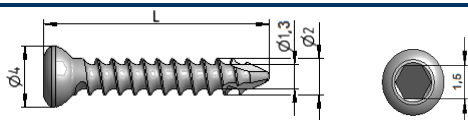

L [mm]	Nr katalogowy / Catalogue No			
				
	SS	T	SS	T
8	223208	223208T	223108	223108T
9	223209	223209T	223109	223109T
10	223210	223210T	223110	223110T
11	223211	223211T	223111	223111T
12	223212	223212T	223112	223112T

L [mm]	Nr katalogowy / Catalogue No			
				
	SS	T	SS	T
13	223213	223213T	223113	223113T
14	223214	223214T	223114	223114T
15	223215	223215T	223115	223115T
16	223216	223216T	223116	223116T



Wkręt do kości drobnych Ø2,0/1,3mm
Screw for small bones Ø2,0/1,3mm

L [mm]	Nr katalogowy / Catalogue No			
				
	SS	T	SS	T
8	222208	222208T	222308	222308T
9	222209	222209T	222309	222309T
10	222210	222210T	222310	222310T
11	222211	222211T	222311	222311T
12	222212	222212T	222312	222312T
13	222213	222213T	222313	222313T
14	222214	222214T	222314	222314T
15	222215	222215T	222315	222315T
16	222216	222216T	222316	222316T

L [mm]	Nr katalogowy / Catalogue No			
				
	SS	T	SS	T
17	222217	222217T	222317	222317T
18	222218	222218T	222318	222318T
19	222219	222219T	222319	222319T
20	222220	222220T	222320	222320T
21	222221	222221T	222321	222321T
22	222222	222222T	222322	222322T
23	222223	222223T	222323	222323T
24	222224	222224T	222324	222324T
25	222225	222225T	222325	222325T

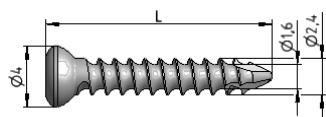

Wkręt do kości drobnych Ø2,4/1,6mm pełnogwintowany, samogwintujący
Screw for small bones Ø2,4/1,6mm fully threaded, self-tapping

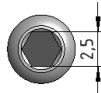
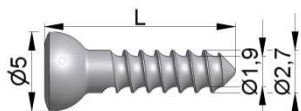

L [mm]	Nr katalogowy Cat No	
	SS	T
10	023010	023010T
12	023012	023012T
14	023014	023014T
15	023015	023015T
16	023016	023016T
18	023018	023018T
20	023020	023020T
22	023022	023022T
24	023024	023024T
25	023025	023025T

L [mm]	Nr katalogowy Cat No	
	SS	T
26	023026	023026T
28	023028	023028T
30	023030	023030T
32	023032	023032T
34	023034	023034T
35	023035	023035T
36	023036	023036T
38	023038	023038T
40	023040	023040T





Wkręt do kości drobnych Ø2,7/1,9mm
Screw for small bones Ø2,7/1,9mm

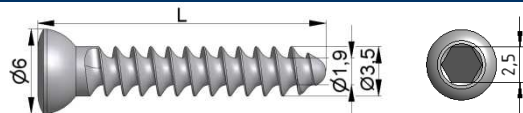

L [mm]	Nr katalogowy / Catalogue No			
				
	SS	T	SS	T
8	221208	221208T	221308	221308T
9	221209	221209T	221309	221309T
10	221210	221210T	221310	221310T
11	221211	221211T	221311	221311T
12	221212	221212T	221312	221312T
13	221213	221213T	221313	221313T
14	221214	221214T	221314	221314T
15	221215	221215T	221315	221315T
16	221216	221216T	221316	221316T
17	221217	221217T	221317	221317T
18	221218	221218T	221318	221318T
19	221219	221219T	221319	221319T
20	221220	221220T	221320	221320T
21	221221	221221T	221321	221321T

L [mm]	Nr katalogowy / Catalogue No			
				
	SS	T	SS	T
22	221222	221222T	221322	221322T
23	221223	221223T	221323	221323T
24	221224	221224T	221324	221324T
25	221225	221225T	221325	221325T
26	221226	221226T	221326	221326T
28	221228	221228T	221328	221328T
30	221230	221230T	221330	221330T
32	221232	221232T	221332	221332T
34	221234	221234T	221334	221334T
35	221235	221235T	221335	221335T
36	221236	221236T	221336	221336T
38	221238	221238T	221338	221338T
40	221240	221240T	221340	221340T





Wkręt do kości drobnych Ø3,5/1,9mm
Screw for small bones Ø3,5/1,9mm

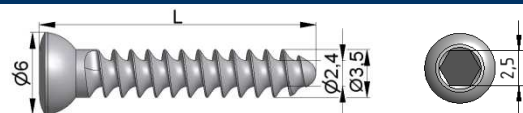

L [mm]	Nr katalogowy / Catalogue No			
				
	SS	T	SS	T
8	220208	220208T	220408	220408T
10	220210	220210T	220410	220410T
12	220212	220212T	220412	220412T
14	220214	220214T	220414	220414T
15	220215	220215T	220415	220415T
16	220216	220216T	220416	220416T
18	220218	220218T	220418	220418T
20	220220	220220T	220420	220420T
22	220222	220222T	220422	220422T
24	220224	220224T	220424	220424T
25	220225	220225T	220425	220425T
26	220226	220226T	220426	220426T
28	220228	220228T	220428	220428T
30	220230	220230T	220430	220430T
32	220232	220232T	220432	220432T
34	220234	220234T	220434	220434T

L [mm]	Nr katalogowy / Catalogue No			
				
	SS	T	SS	T
35	220235	220235T	220435	220435T
36	220236	220236T	220436	220436T
38	220238	220238T	220438	220438T
40	220240	220240T	220440	220440T
42	220242	220242T	220442	220442T
44	220244	220244T	220444	220444T
45	220245	220245T	220445	220445T
46	220246	220246T	220446	220446T
48	220248	220248T	220448	220448T
50	220250	220250T	220450	220450T
52	220252	220252T	220452	220452T
54	220254	220254T	220454	220454T
55	220255	220255T	220455	220455T
56	220256	220256T	220456	220456T
58	220258	220258T	220458	220458T
60	220260	220260T	220460	220460T



Wkręt do kości drobnych Ø3,5/2,4mm
Screw for small bones Ø3,5/2,4mm

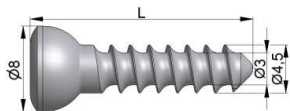

L [mm]	Nr katalogowy / Catalogue No			
				
	SS	T	SS	T
14	220514	220514T	220714	220714T
15	220515	220515T	220715	220715T
16	220516	220516T	220716	220716T
18	220518	220518T	220718	220718T
20	220520	220520T	220720	220720T
22	220522	220522T	220722	220722T
24	220524	220524T	220724	220724T
25	220525	220525T	220725	220725T
26	220526	220526T	220726	220726T
28	220528	220528T	220728	220728T
30	220530	220530T	220730	220730T
32	220532	220532T	220732	220732T
34	220534	220534T	220734	220734T

L [mm]	Nr katalogowy / Catalogue No			
				
	SS	T	SS	T
35	220535	220535T	220735	220735T
36	220536	220536T	220736	220736T
38	220538	220538T	220738	220738T
40	220540	220540T	220740	220740T
42	220542	220542T	220742	220742T
44	220544	220544T	220744	220744T
45	220545	220545T	220745	220745T
46	220546	220546T	220746	220746T
48	220548	220548T	220748	220748T
50	220550	220550T	220750	220750T
55	220555	220555T	220755	220755T
60	220560	220560T	220760	220760T



Wkręt do kości korowej Ø4,5/3,0mm
Cortex screw Ø4,5/3,0mm

L [mm]	Nr katalogowy / Catalogue No			
				
	SS	T	SS	T
12	200212	200212T	200512	200512T
14	200214	200214T	200514	200514T
16	200216	200216T	200516	200516T
18	200218	200218T	200518	200518T
20	200220	200220T	200520	200520T
22	200222	200222T	200522	200522T
24	200224	200224T	200524	200524T
26	200226	200226T	200526	200526T
28	200228	200228T	200528	200528T
30	200230	200230T	200530	200530T
32	200232	200232T	200532	200532T
34	200234	200234T	200534	200534T
36	200236	200236T	200536	200536T

L [mm]	Nr katalogowy / Catalogue No			
				
	SS	T	SS	T
38	200238	200238T	200538	200538T
40	200240	200240T	200540	200540T
42	200242	200242T	200542	200542T
44	200244	200244T	200544T	200544T
46	200246	200246T	200546	200546T
48	200248	200248T	200548	200548T
50	200250	200250T	200550	200550T
52	200252	200252T	200552	200552T
54	200254	200254T	200554	200554T
56	200256	200256T	200556	200556T
58	200258	200258T	200558	200558T
60	200260	200260T	200560	200560T

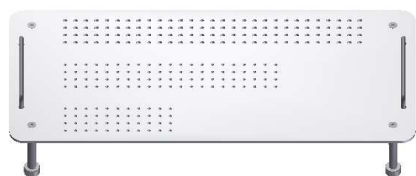

Paleta na wkręty
Tray for screws

Na wkręty/ For screws	Kaseta sterylizacyjna/ Sterilization container	Nr katalogowy Cat No
Ø1,5; Ø2,0	540015	540024
Ø1,5; Ø2,0; Ø2,7	540015	540036
Ø3,5; Ø4,5	540015	540038

PODKŁADKI/ WASHERS

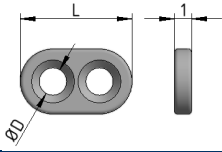

Podkładka do więzadła krzyżowego
Washer for ACL cruciate ligament

L [mm]	ØD [mm]	Nr katalogowy Cat No
6,5	1,6	292240
9,0	2,0	292250

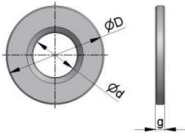

Podkładka pod wkręty
Washer for screws

Grubość [mm] Thickness [mm]	D [mm]	d [mm]	Ø wkręta Ø of screw	Nr katalogowy Cat No
1	7	2,8	2,0; 2,7	292004
1,5	7	4,2	3,5; 4,0	292005
	11			292007
	11	5	4,5	292010
	13			292015
	16			292016
	19	6,7	6,5	292018
	19	5	4,5	292020
	11	6,7	6,5	292210
	13			292215
	13	7,2	7,0 kaniulowane cannulated	292113
	16			292115
	19			292120

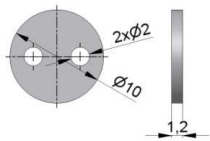

Podkładka 2-otworowa
2-holes washer

Nr katalogowy
Cat No

292110

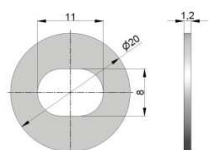

Podkładka z otworem owalnym
Washer with oval hole

Nr katalogowy
Cat No

292220

DRUTY/ WIRES



Drut do wiązania odłamów kostnych
Cerclage wire

L [m]	ØD [mm]	Nr katalogowy Cat No
		SS
5	0,2	300205
	0,3	300305
	0,4	300405
	0,5	300505
	0,6	300605
	0,7	300705
	0,8	300805
	0,9	300905
	1,0	301005
	1,2	301205
	1,5	301505
	1,8	301805
	2,0	302005



Blokada cerklarzu do otworów samodociskowych
pod wkręty Ø3,5 mm i Ø4,0 mm
Cerclage button for self-compressing holes
for screws Ø3,5 mm and Ø4,0 mm

A [mm]	Nr katalogowy Cat No
2,5	022025
3,0	022030
4,0	022040

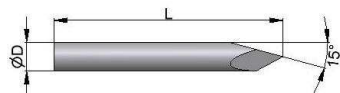

Drut Kirschnera z ostrzem jednostronnym typu trokar
Kirschner wire with trocar tip

ØD [mm]	Nr katalogowy Cat No			
	SS			
	L [mm]			
	150	210	310	400
1,0	311015	311021	311031	–
1,1	311115	311121	311131	–
1,2	311215	311221	311231	–
1,4	311415	311421	311431	–
1,5	311515	311521	311531	–
1,6	311615	311621	311631	–
1,8	311815	311821	311831	–
2,0	312015	312021	312031	312040
2,2	312215	312221	312231	312240
2,4	312415	312421	312431	312440
2,5	312515	312521	312531	312540
3,0	–	–	313031	313040
3,5	313515	313521	313531	313540

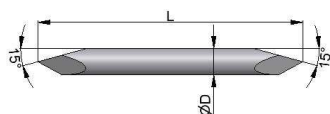

Drut Kirschnera z ostrzem obustronnym typu trokar
Kirschner wire with double trocar tip

ØD [mm]	Nr katalogowy Cat No			
	SS			
	L [mm]			
	150	210	310	400
1,0	311015D	311021D	311031D	–
1,1	311115D	311121D	311131D	–
1,2	311215D	311221D	311231D	–
1,4	311415D	311421D	311431D	–
1,5	311515D	311521D	311531D	–
1,6	311615D	311621D	311631D	–
1,8	311815D	311821D	311831D	–
2,0	312015D	312021D	312031D	312040D
2,2	312215D	312221D	312231D	312240D
2,4	312415D	312421D	312431D	312440D
2,5	312515D	312521D	312531D	312540D
3,0	–	–	313031D	313040D
3,5	313515D	313521D	313531D	313540D

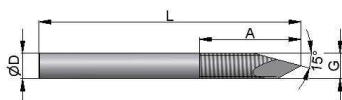

Drut Kirschnera z ostrzem gwintowanym typu trokar
Kirschner wire with threaded tip

A [mm]	G	ØD [mm]	Nr katalogowy Cat No			
			SS			
			L [mm]			
			150	200	250	310
5	M1	1,0	311000	311003	311004	311006
	M1,2	1,2	311201	311204	311205	311200
	M1,5	1,5	311501	311504	311505	311507
15	M1,6	1,6	311601	311604	311605	311607
	M1,8	1,8	311801	311804	311805	311807
	M2,0	2,0	312001	312004	312005	312000
	M2,5	2,5	312501	312504	312505	312507
	M3,0	3,0	313001	313004	313005	313007

GROTOWKRĘTY/ PINS

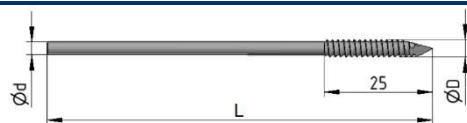

Grotowkręt Schanza z pozytywnym gwintem
Schanz screw with positive thread

$\varnothing D$ [mm]	$\varnothing d$ [mm]	L [mm]	Nr katalogowy Cat No	
			SS	
Ø2,0	Ø1,6	89	362820	
Ø3,5	Ø2,4	89	362835	
Ø4,0	Ø2,9	127	362840	

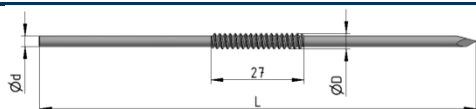

Grotowkręt Schanza z centralnym gwintem
Schanz screw with central thread

$\varnothing D$ [mm]	$\varnothing d$ [mm]	Nr katalogowy Cat No	
		SS	
		L [mm]	
		127	177
Ø2,0	Ø1,6	362922	362927
Ø3,5	Ø2,2	362932	362937
Ø4,0	Ø3,0	362942	362947



Grotokręt Schanza samogwintujący
Schanz screw self-tapping

L [mm]	Nr katalogowy Cat No					
	SS					
	A = 25mm		A = 36mm			
	ØD = 2,5mm	ØD = 3,0mm	ØD = 4,0mm	ØD = 4,5mm	ØD = 5,0mm	ØD = 6,0mm
S = 2,0mm	S = 2,4mm	S = 3,2mm	S = 3,6mm	S = 4,0mm	S = 4,8mm	
60	362506	363006	364006	364506	365006	366006
70	362507	363007	364007	364507	365007	366007
80	362508	363008	364008	364508	365008	366008
90	362509	363009	364009	364509	365009	366009
100	362510	363010	364010	364510	365010	366010
110	362511	363011	364011	364511	365011	366011
120	362512	363012	364012	364512	365012	366012
130	362513	363013	364013	364513	365013	366013
140	362514	363014	364014	364514	365014	366014
150	362515	363015	364015	364515	365015	366015
160	362516	363016	364016	364516	365016	366016
170	362517	363017	364017	364517	365017	366017
180	362518	363018	364018	364518	365018	366018
190	362519	363019	364019	364519	365019	366019
200	362520	363020	364020	364520	365020	366020
210	362521	363021	364021	364521	365021	366021
220	362522	363022	364022	364522	365022	366022
250	362525	363025	364025	364525	365025	366025
280	362528	363028	364028	364528	365028	366028
300	362530	363030	364030	364530	365030	366030
320	362532	363032	364032	364532	365032	366032

SYSTEM ZESPOL



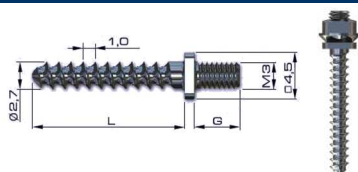

Płytkę samociskowa wąska ZESPOL MIKRO
ZESPOL MIKRO narrow plate self-compressing

Otworki/ Holes	A [mm]	L [mm]	Nr katalogowy Cat No
2	8	16	123402
2	16	24	123502
4	8	32	123404
4	16	40	123504
6	16	56	123406
6	32	72	123506



Wkręt do kości drobnych ZESPOL MIKRO Ø2,7mm z nakrętką
ZESPOL MIKRO screw for small bones Ø2,7mm with nut

L [mm]	Nr katalogowy Cat No	
		
	G=4,5mm	
8	221408	231408
10	221410	231410
12	221412	231412
14	221414	231414
16	221416	231416
18	221418	231418
20	221420	231420
22	221422	231422
24	221424	231424

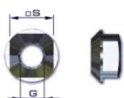

Nakrętka do wkrętów ZESPOL MIKRO
Nut for ZESPOL MIKRO screws

G [mm]	S [mm]	Nr katalogowy Cat No
		SS
M3	4,5	290430

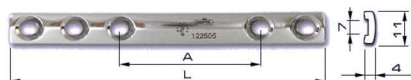

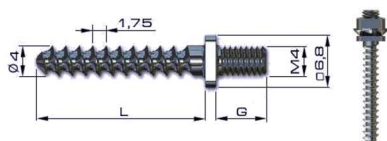

Płytkę ZESPOL MINI samodociskowa 11x4mm
ZESPOL MINI plate self-compression 11x4 mm

Otworki/ Holes	A [mm]	L [mm]	Nr katalogowy Cat No
4	32	78	122404
4	48	94	122504
5	32	94	122405
5	48	110	122505
6	32	110	122406
6	48	126	122506
6	64	142	122606



Wkręt do kości korowej ZESPOL MINI Ø4,0mm z nakrętką
ZESPOL MINI cortex screw Ø4,0mm with nut

L [mm]	Nr katalogowy Cat No	
		
	G=6,5mm	
16	241416	251416
18	241418	251418
20	241420	251420
22	241422	251422
24	241424	251424
26	241426	251426
28	241428	251428
30	241430	251430
32	241432	251432
34	241434	251434
36	241436	251436
38	241438	251438
40	241440	251440

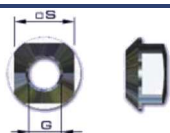

Nakrętka do wkrętów ZESPOL MINI
Nut for ZESPOL MINI screws

G [mm]	S [mm]	Nr katalogowy Cat No
		SS
M4	6,8	290440

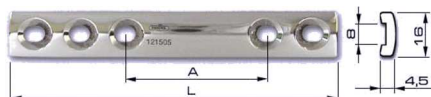

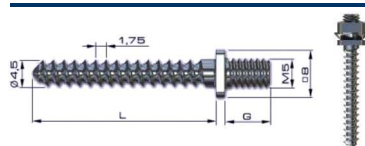

Płytki ZESPOL STANDARD samodociskowa
ZESPOL STANDARD plate self-compression

Otworki/ Holes	A [mm]	L [mm]	Nr katalogowy Cat No
4	32	82	121404
4	48	98	121504
6	32	114	121406
6	48	130	121506
6	64	146	121606
8	32	146	121408



Wkręt do kości korowej ZESPOL STANDARD Ø4,5mm z nakrętką
ZESPOL STANDARD cortex screw Ø4,5mm with nut

L [mm]	Nr katalogowy Cat No	
		
	G=7,5mm	
26	200426	210426
28	200428	210428
30	200430	210430
32	200432	210432
34	200434	210434
36	200436	210436
38	200438	210438
40	200440	210440
42	200442	210442
44	200444	210444

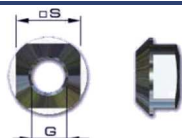

Nakrętka do wkrętów ZESPOL STANDARD
Nut for ZESPOL STANDARD screws

G [mm]	S [mm]	Nr katalogowy Cat No
		SS
M5	8,0	290450

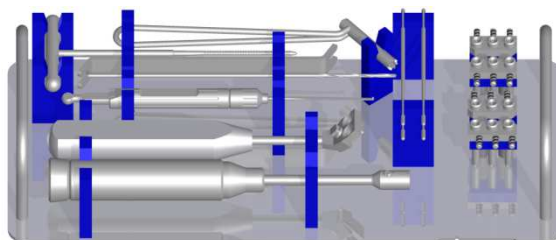
ZESTAW INSTRUMENTÓW ZESPOL MIKRO
 ZESPOL MICRO – SET OF INSTRUMENTS

Lp.	Nazwa elementu / Description	Nr katalogowy Cat No	Ilość Quantity
1	Uchwyt prowadniczy kostkowej ZESPOL MIKRO Guide holder ZESPOL MIKRO	750029	1
2	Kostka 3-otworowa „0” ZESPOL MIKRO ZESPOL blocks MIKRO 3 holes compressing „0”	750024	2
3	Kostka 3-otworowa „0,8” ZESPOL MIKRO ZESPOL blocks MIKRO 3 holes compressing „0,8”	750025	1
4	Kostka 3-otworowa „1,6” ZESPOL MIKRO ZESPOL blocks MIKRO 3 holes compressing „1,6”	750026	1
5	Pręt ustalający Ø2,0mm ZESPOL Seating rod Ø2,0mm	750028	6
6	Miarka głębokości L=50mm Depth gauge L=50mm	771020	1
7	Wiertło Ø2,0mm Drill Ø2,0mm	711020	1
8	Gwintownik Ø2,7x1,0mm Tap Ø2,7x1,0mm	720027	1
9	Oslona gwintownika Ø2,7mm Tap sleeve Ø2,7mm	730027	1
10	Klucz płaski 4,5 ZESPOL MIKRO Wrench ZESPOL MIKRO 4,5mm	760031	1
11	Klucz uniwersalny – MIKRO Universal spanner - MIKRO	760010	1
12	Paleta na instrumentarium ZESPOL MIKRO Tray for instruments ZESPOL MIKRO	540054	1
Elementy dodatkowe / Additional elements			
13	Paleta na implanty ZESPOL MIKRO Tray for implants ZESPOL MIKRO	540052	opcjonalnie optional
14	Kaseta sterylizacyjna Sterilization container	540016	opcjonalnie optional

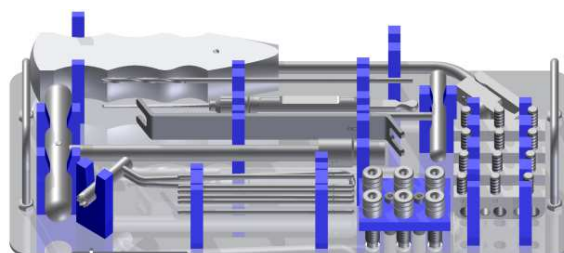
ZESTAW INSTRUMENTÓW ZESPOL MINI
ZESPOL MINI – SET OF INSTRUMENTS

Lp.	Nazwa elementu / Description	Nr katalogowy Cat No	Ilość Quantity
1	Uchwyt prowadnicy kostkowej ZESPOL MINI Guide holder ZESPOL MINI	751030	1
2	Kostka 3-otworowa "0" ZESPOL MINI ZESPOL blocks MINI 3 holes compressing „0”	751034	2
3	Kostka 3-otworowa "1" ZESPOL MINI ZESPOL blocks MINI 3 holes compressing „1”	751035	1
4	Kostka 3-otworowa "2" ZESPOL MINI ZESPOL blocks MINI 3 holes compressing „2”	751036	1
5	Tulejka wiertarska Ø2,7mm Drilling sleeve Ø2,7mm	751127	6
6	Pręt ustalający Ø2,5mm ZESPOL seating rod Ø2,5mm	751128	6
8	Miarka głębokości L=50mm Depth gauge L=50mm	771020	1
7	Wiertło Ø2,7x150mm Drill Ø2,7x150mm	711027	1
9	Gwintownik Ø4,0x1,75mm Tap Ø4,0x1,75mm	720040	1
12	Oslona gwintownika Ø4,0mm Tap sleeve Ø4,0mm	730040	1
10	Klucz płaski Flat spanner	760030	1
11	Klucz z pokrętką – mini Spanner with handle - mini	760020	1
13	Paleta na instrumentarium ZESPOL MINI Tray for instruments ZESPOL MINI	540051	1
Elementy dodatkowe / Additional elements			
14	Paleta na implanty ZESPOL MINI Tray for implants ZESPOL MINI	540050	opcjonalnie optional
15	Kaseta sterylizacyjna Sterilization container	540016	opcjonalnie optional

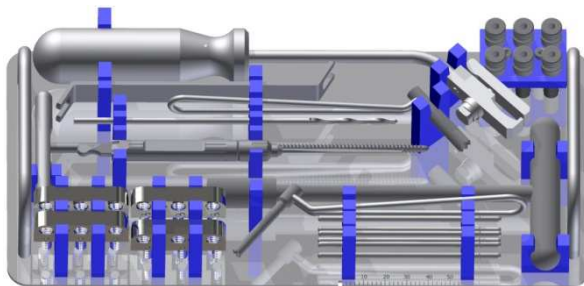
**ZESTAW INSTRUMENTÓW ZESPOL STANDARD
ZESPOL STANDARD – SET OF INSTRUMENTS**

Lp.	Nazwa elementu / Description	Nr katalogowy Cat No	Ilość Quantity
1	Uchwyt prowadnicy kostkowej ZESPOL STANDARD Guide holder ZESPOL STANDARD	751029	1
2	Kostka 3-otworowa "0" ZESPOL STANDARD ZESPOL blocks STANDARD 3 holes compressing „0”	751024	2
3	Kostka 3-otworowa "1" ZESPOL STANDARD ZESPOL blocks STANDARD 3 holes compressing „1”	751025	1
4	Kostka 3-otworowa "2" ZESPOL STANDARD ZESPOL blocks STANDARD 3 holes compressing „2”	751026	1
5	Tulejka wiertarska Ø3,2mm Drilling sleeve Ø3,2mm	751227	6
6	Pręt ustalający Ø3,0mm ZESPOL seating rod Ø3,0mm	751228	6
8	Miarka głębokości L=50mm Depth gauge L=50mm	771020	1
7	Wiertło Ø3,2x150mm Drill Ø3,2x150mm	711032	1
9	Gwintownik Ø4,5x1,75mm Tap Ø4,0x1,75mm	720045	1
12	Oslona gwintownika Ø4,5mm Tap sleeve Ø4,5mm	730045	1
10	Klucz płaski Flat spanner	760030	1
11	Klucz z pokrętką Spanner with handle i	761020	1
12	Prowadnica wiertła ø3,2 Drill guide ø3,2	750080	1
13	Paleta na instrumentarium ZESPOL STANDARD Tray for instruments ZESPOL STANDARD	540056	1
Elementy dodatkowe / Additional elements			
14	Paleta na implanty ZESPOL STANDARD Tray for implants ZESPOL STANDARD	540055	opcjonalnie optional
15	Kaseta sterylizacyjna Sterilization container	540016	opcjonalnie optional

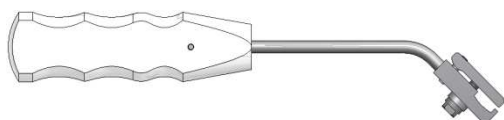

Uchwyt prowadnicy kostkowej
Guide holder

Dla For	Nr katalogowy Cat No
ZESPOL MIKRO	750029
ZESPOL MINI	751030
ZESPOL STANDARD	751029

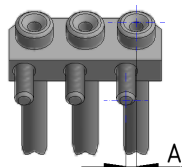

Kostka 3-otworowa ZESPOL MIKRO
Block 3 holes ZESPOL MIKRO

A [mm]	Nr katalogowy Cat No
0	750024
0,8	750025
1,6	750026

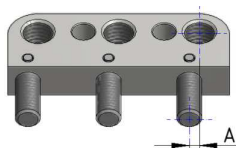

Kostka 3-otworowa
Block 3 holes

A [mm]	Nr katalogowy Cat No	
	ZESPOL MINI	ZESPOL STANDARD
0	751034	751024
1	751035	751025
2	751036	751026



Tulejka wiertarska
Drill sleeve

Dla For	ØD	Nr katalogowy Cat No
ZESPOL MIKRO	2,7	751127
ZESPOL MINI	3,2	751227



Pręt ustalający
Fixing bar

Długość For	ØD	Nr katalogowy Cat No
ZESPOL MIKRO	Ø2,0	750028
ZESPOL MINI	Ø2,5	751128
ZESPOL STANDARD	Ø3,0	751228



Miarka głębokości L=50mm
Depth gauge L=50mm

Nr katalogowy Cat No
771020



Wiertło
Drill

Długość For	ØD	Nr katalogowy Cat No
ZESPOL MIKRO	Ø2,0	711020
ZESPOL MINI	Ø2,7	711027
ZESPOL STANDARD	Ø3,2	711032



Gwintownik
Tap

Długość For	ØD	Nr katalogowy Cat No
ZESPOL MIKRO	Ø2,7	720027
ZESPOL MINI	Ø4,0	720040
ZESPOL STANDARD	Ø4,5	720045



Osłona gwintownika
Tap sleeve

Dla For	ØD	Nr katalogowy Cat No
ZESPOL MIKRO	Ø2,7	730027
ZESPOL MINI	Ø4,0	730040
ZESPOL STANDARDI	Ø4,5	730045

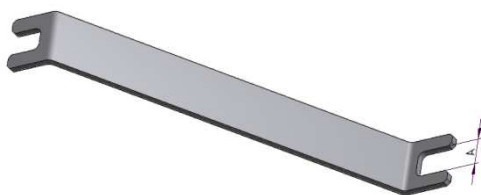

Klucz płaski ZESPOL
Wrench ZESPOL

Dla For	A [mm]	Nr katalogowy Cat No
ZESPOL MIKRO	4,5	760031
ZESPOL MINI	7,1	760030
ZESPOL STANDARD	8,1	760030



Klucz ZESPOL MIKRO
Spanner ZESPOL MIKRO

A [mm]	Nr katalogowy Cat No
4,5	760010

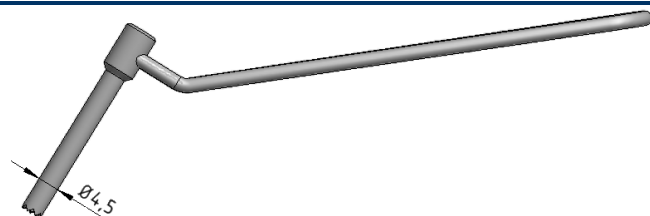

Prowadnica wiertła ø3,2 ZESPOL STANDARD
Drill guide ø3,2 ZESPOL STANDARD

Nr katalogowy
Cat No

750080

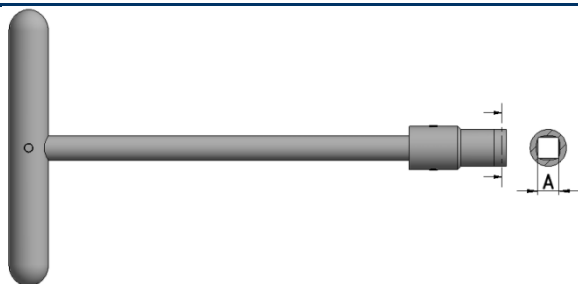

Klucz ZESPOL
Spanner ZESPOL

Dla For	A [mm]	Nr katalogowy Cat No
ZESPOL MINI	7,1	760020
ZESPOL STANDARD	8,1	761020

Palety sterylizacyjne na implanty (bez implantów)
Sterilization trays for implants (without implants)

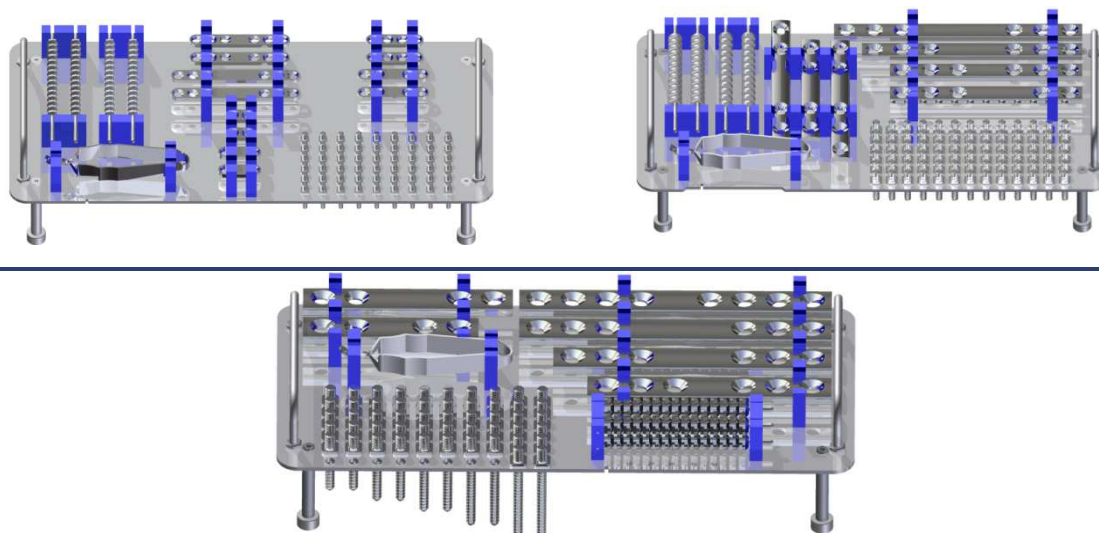

Nazwa/ Description	Kaseta sterylizacyjna/ Sterilization container	Nr katalogowy Cat No
Paleta na implanty ZESPOL MIKRO Tray for implants ZESPOL MIKRO	540016	540052
Paleta na implanty ZESPOL MINI Tray for implants ZESPOL MINI	540016	540050
Paleta na implanty ZESPOL STANDARD Tray for implants ZESPOL STANDARD	540016	540055

Palety sterylizacyjne do zestawu narzędzi (bez narzędzi)
Sterilization trays for set of instruments (without instruments)

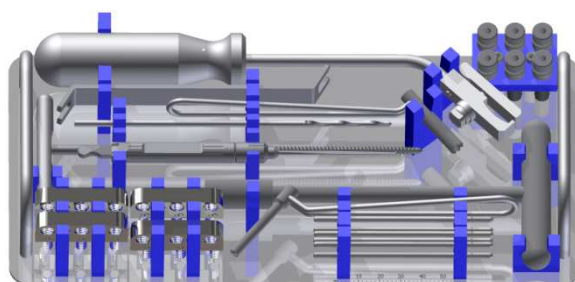
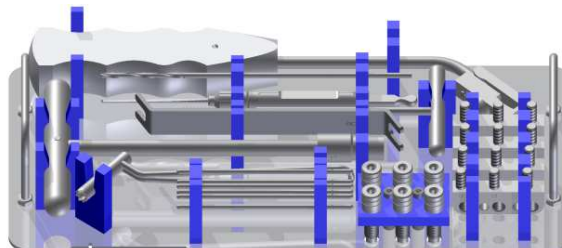
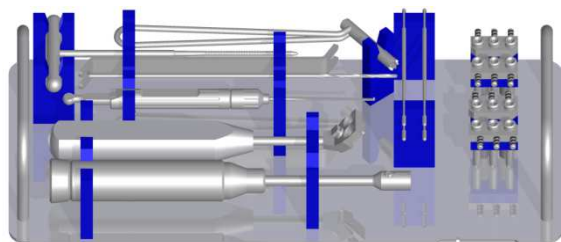

Nazwa/ Description	Kaseta sterylizacyjna/ Sterilization container	Nr katalogowy Cat No
Paleta na instrumentarium ZESPOL MIKRO Tray for instruments ZESPOL MIKRO	540016	540054
Paleta na instrumentarium ZESPOL MINI Tray for instruments ZESPOL MINI	540016	540051
Paleta na instrumentarium ZESPOL STANDARD Tray for instruments ZESPOL STANDARD	540016	540056

INSTRUMENTY / INSTRUMENTS

WKREŃTAKI / SCREWDRIVERS



Wkręćtak heksagonalny
Hexagonal screwdriver

Ø wkręta/ Ø of screw	L [mm]	S [mm]	Nr katalogowy Cat No
1,5-2,0	80	1,5	780200
2,4	80	2,0	781201
2,7-4,0	120	2,5	781200
4,5-6,5	120	3,5	782200



Wkręćtak torx
Torx screwdriver

Ø wkręta/ Ø of screw	L [mm]	S [mm]	Nr katalogowy Cat No
1,5	80	T7	783307
2,0-2,4	80	T8	783308
2,7-4,0	120	T15	783315
4,5-6,5	120	T25	783325

WIERTŁA / DRILLS

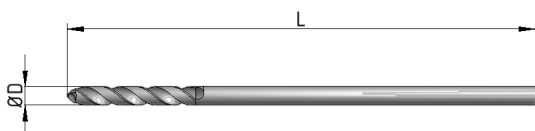

Wiertło
Drill

ØD [mm]	L [mm]	Nr katalogowy Cat No
1,0	90	711010
1,5	100	711015
1,8	150	711518
2,0	150	711020
2,2	150	711022
2,5	150	711025
2,7	150	711027
3,0	150	711030
3,2	150	711032

ØD [mm]	L [mm]	Nr katalogowy Cat No
3,5	150	711035
3,7	150	711037
4,0	150	711040
4,2	150	711042
4,5	150	711045
4,7	150	711047
5	150	711050
6	150	711060
7	150	711070

PROWADNIKI/ GUIDES

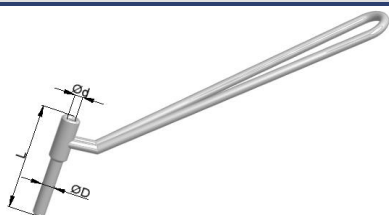

Prowadnik wiertła
Drill guide

Ød wiertła [mm] Ød of drill [mm]	ØD [mm]	L [mm]	Nr katalogowy Cat No
1,0	2,5	25	750070
1,5	3,0	25	750073
2,0	4,0	35	750074
2,5	4,0	35	750075
3,0	5,0	35	750079
3,2	4,5	35	750072
3,7	5,0	35	750077
3,2	6,5	40	750071
4,2	6,5	40	750082
4,7	7,0	45	750081



Celownik do płyt kompresyjnych
otwory samodociskowe
Drill guide for compression plates
self-compressing holes

ØD [mm]	Ød wiertła [mm] Ød of drill [mm]	Nr katalogowy Cat No
10	3,2	750200
8	2,0	750201
8	2,0	750202
8	2,5	750211

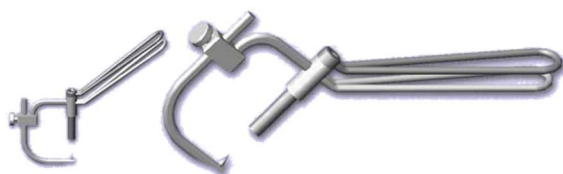

Prowadnik centrujący
Centering guide

Opis/ Description		Nr katalogowy Cat No
Prowadnik centrujący – komplet Centering guide - set		750700
1	Tuleja Ø4,5mm Sleeve Ø4,5mm	750701
2	Tuleja Ø3,2mm Sleeve Ø3,2mm	750702
3	Tuleja Ø2,0mm Sleeve Ø2,0mm	750703
4	Korpus prowadnika centrującego Body of the centering guide	750704

GWINTOWNIKI/ TAPS

 Gwintownik z pokrętką
Tap with T-handle

Ø [mm]	S [mm]	B [mm]	Nr katalogowy Cat No
1,5/1,0	0,5	20	720015
2,0/1,3	0,6	20	720020
2,4/1,6	1,0	27	720024
2,7/1,9	1,0	27	720027
3,5/1,9	1,25	45	720035
3,5/2,4	1,25	50	720235
4,0/1,9	1,75	50	720140
4,5/3,0	1,75	70	720045

OSŁONY GWINTOWNIKÓW/ TAP SLEEVES

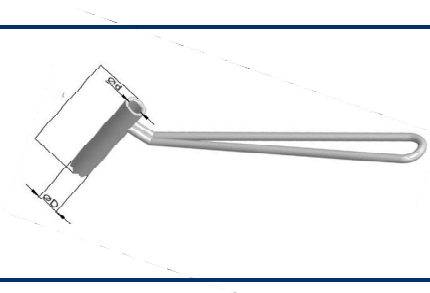
 Osłona gwintownika
Tap sleeve

Dla gwintownika For tap	Ød [mm]	ØD [mm]	L[mm]	Nr katalogowy Cat No
1,5	1,7	6	25	730015
2	2,2	6	25	730020
2,4	2,5	4	35	750075
2,7	2,9	6	35	730027
3,5	3,7	6	35	730035
4	4,4	7	35	730040
4,5	4,7	7	40	730045

MIARKI/ GAUGES



Miarka głębokości
Depth gauge

Dla wkrętów For screws	Zakres pomiarowy [mm] Measuring range [mm]	Nr katalogowy Cat No
Ø1,5 - Ø2,7	40	772020
Ø3,5 - Ø5,0	50	772030
Ø3,5 - Ø6,5	90	772040

WYGINAKI/ BENDING INSTRUMENTS

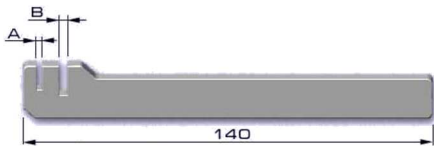

Wyginak płytek 1,5mm i 2,5mm
Bending iron for plates 1,5mm and 2,5mm

A [mm]	B [mm]	Nr katalogowy Cat No
1,5	2,5	790530
2,5	1,5	790531

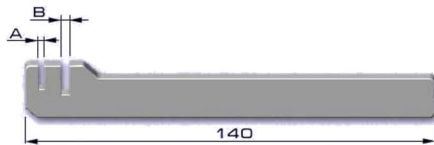

Wyginak płytek 2,7mm i 3,5mm
Bending iron for plates 2,7mm and 3,5mm

A [mm]	B [mm]	Nr katalogowy Cat No
2,7	3,5	790534
3,5	2,7	790535

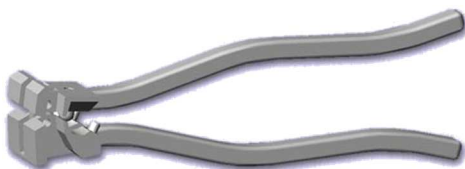

Wyginak płytek rekonstrukcyjnych
Bending iron for reconstruction plates

Nr katalogowy
Cat No

790543

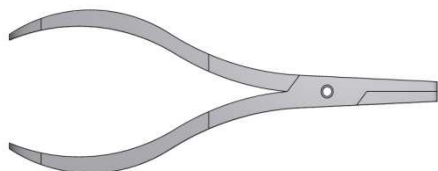

Wyginak go płytek drobnych
Bending pliers for small plates

Nr katalogowy
 Cat No

470020

KLESZCZE/ FORCEPS



Kleszcze do ucinania gwoździ do 3,6mm
Forceps for nails cutting up to 3,6mm

Nr katalogowy
 Cat No

419005



Boczne kleszcze do ucinania gwoździ do 2,4mm
Lateral forceps for cutting nails up to 2,4mm

Nr katalogowy
 Cat No

419030

UCHWYTY/ HANDLES

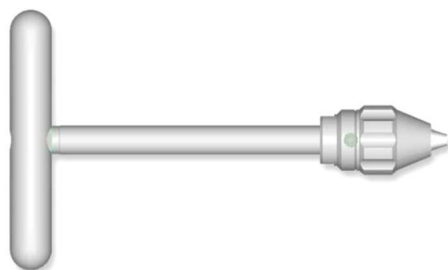

Uchwyt do gwoździ
Handle for nails

Nr katalogowy
 Cat No

763006

INNE/ OTHERS

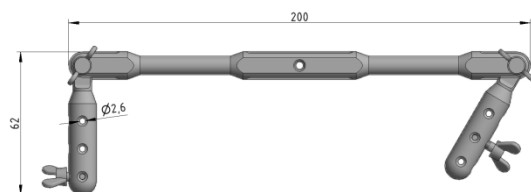

Uchwyt do osteotomii
Holder for osteotomy

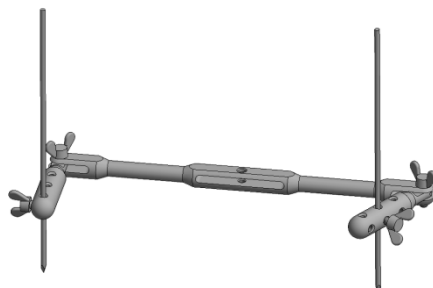

Nazwa Name		Sztuk w zestawie Pieces in set	Nr katalogowy Cat No
Uchwyt do osteotomii (komplet)		1	900015
1.	Ramię główne	1	900015/1
2.	Ramię boczne	2	900015/2
3.	Śruba skrzydełkowa	4	900015/3
4.	Drut Kirschnera M2,5x150mm	2	312501



Kontener sterylizacyjny
Sterilization container

Długość x Szerokość x wysokość[mm] (wymiary wewnętrzne) Length x Width x Height [mm] (internal dimensions)	Nr katalogowy Cat No
280x130x55	540015
280x130x84	540016

DOBÓR KĄTA TPŁO

TPLO ROTATION – REFERENCE CHART



KĄT TPA PRZED ZABIEGIEM

PREOPERATIVE TIBIAL PLATEAU ANGLE (TPA)

15°	16°	17°	18°	19°	20°	21°	22°	23°	24°	25°	26°	27°	28°	29°	30°	31°	32°	33°	34°	35°	36°	37°	38°	39°	40°
-----	-----	-----	-----	-----	-----	-----	-----	-----	-----	-----	-----	-----	-----	-----	-----	-----	-----	-----	-----	-----	-----	-----	-----	-----	-----

ROTACJA W MM ZAPEWNIAJĄCA REDUKCJĘ KĄTA DO 5°

ROTATION [MM] – PROVIDES RESULT 5° TPA

ROZMIAR OSTRZA / SAW RADIUS	12mm	2.0	2.2	2.4	2.6	2.9	3.1	3.3	3.5	3.7	3.9	4.1	4.3	4.5	4.7	4.9	5.1	5.3	5.5	5.7	5.9	6.1	6.3	6.4	6.6	6.8	7.0
	15mm	2.6	2.8	3.1	3.3	3.6	3.8	4.1	4.3	4.6	4.9	5.1	5.4	5.6	5.9	6.1	6.4	6.6	6.9	7.1	7.4	7.6	7.9	8.1	8.4	8.6	8.8
	18mm	3.1	3.4	3.7	4.0	4.3	4.6	4.9	5.2	5.5	5.8	6.1	6.5	6.8	7.1	7.4	7.7	8.0	8.3	8.6	8.9	9.2	9.5	9.8	10.1	10.3	10.6
	21mm	3.6	4.0	4.3	4.7	5.0	5.4	5.8	6.1	6.5	6.8	7.2	7.5	7.9	8.3	8.6	9.0	9.3	9.7	10.0	10.4	10.7	11.1	11.4	11.8	12.1	12.4
	24mm	4.1	4.5	5.0	5.4	5.8	6.2	6.6	7.0	7.4	7.8	8.2	8.6	9.0	9.5	9.9	10.3	10.7	11.1	11.5	11.9	12.3	12.7	13.1	13.5	13.9	14.3
	27mm	4.7	5.1	5.6	6.0	6.5	7.0	7.4	7.9	8.4	8.8	9.3	9.7	10.2	10.6	11.1	11.6	12.0	12.5	12.9	13.4	13.8	14.3	14.7	15.2	15.6	16.1
	30mm	5.2	5.7	6.2	6.7	7.2	7.8	8.3	8.8	9.3	9.8	10.3	10.8	11.3	11.8	12.3	12.9	13.4	13.9	14.4	14.9	15.4	15.9	16.4	16.9	17.4	17.9

DOBÓR IMPLANTÓW TTA SELECTION OF TTA IMPLANTS

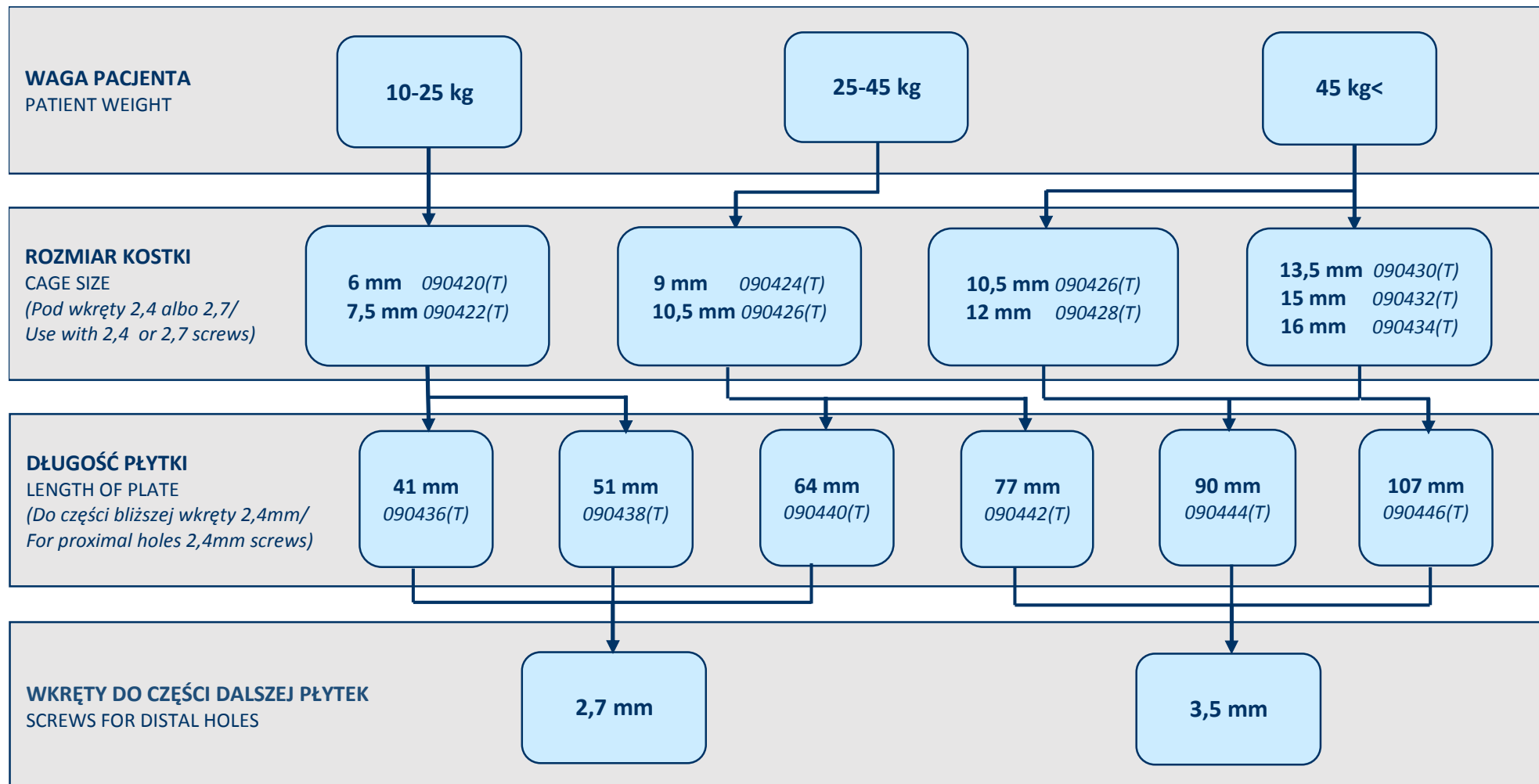

REKOMENDOWANE NARZĘDZIA DO IMPLANTACJI WKRĘTÓW BHH MIKROMED RECOMMENDED INSTRUMENTS FOR BHH MIKROMED SCREWS IMPLANTATION







Wkręty lite	Wiertło z chwytem walcowym	Gwintownik z pokrętką	Wkrętaki z uchwytem
Ø1,5 / Ø1,0	Ø1,0	Ø1,5 / Ø1,0 x 0,5	S1,5
	711010	720015	780200
Ø2,0 / Ø1,3	Ø1,5	Ø2,0 / Ø1,3 x 0,6	S1,5
	711015	721020	780200
Ø2,4 / Ø1,6	Ø1,8	Ø2,4 / Ø1,6 x 1,0	S2,0
	711518	720024	781201
Ø2,7 / Ø1,9	Ø2,0	Ø2,7 / Ø1,9 x 1,0	S2,5
	711020	720027	781200
Ø3,5 / Ø1,9	Ø2,0	Ø3,5 / Ø1,9 x 1,25	S2,5
	711020	720035	781200
Ø3,5 / Ø2,4	Ø2,5	Ø3,5 / Ø2,4 x 1,25	S2,5
	711025	720235	781200
Ø4,0 / Ø1,9	Ø2,0	Ø4,0 / Ø1,9 x 1,75	S2,5
	711020	720140	781200
Ø4,5 / Ø3,0	Ø3,2	Ø4,5 / Ø3,0 x 1,75	S3,5
	711032	720045	782200
Ø6,5 / Ø3,0	Ø3,2	Ø6,5 / Ø3,0 x 2,75	S3,5
	711032	720065	782200

TABELA DOBORU ŚREDNICY WKRETA WZGLĘDEM WAGI PACJENTA CHART OF SCREW DIAMETER RELATIVE TO PATIENTS WEIGHT

	kg:	1	2	3	4	5	6	7	8	9	15	20	25	30	35	40	45	50	55	60	65	70	75	80		
Śródrecze / Śródstopie Metacarpus / Metatarsus											2.0														2.7	
Kość piszczelowa Tibia																										4.5
Kość udowa Femur																										4.5
Miednica Pelvis																										3.5
Kość promieniowa Radius																										4.5
Kość łokciowa Ulna																										3.5
Kość ramienna Humerus																										4.5
Łopatka Scapula																										3.5

SPIS OZNACZEŃ KOLORYSTYCZNYCH NARZĘDZI SYSTEMÓW PŁYTEK BLOKOWANYCH

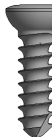
COLOUR CODING OF LOCKING SYSTEM INSTRUMENTS

SYSTEM	2,4 SYSTEM Mikromed Locking Plates			3,5 SYSTEM Mikromed Locking Plates			
	ŚREDNICA GWINTU THREAD DIAMETER	Ø2,4mm	Ø2,7mm	KOROWY/ CORTEX Ø2,7mm	Ø2,7mm	Ø3,5mm	KOROWY/ CORTEX Ø3,5mm
TYP WKRETA SCREW TYPE	LITY/ SOLID	LITY/ SOLID	LITY/ SOLID	LITY/ SOLID	LITY/ SOLID	LITY/ SOLID	LITY/ SOLID
KOLOR WKRETA (TYLKO WERSJA TYTANOWA) SCREW COLOUR (ONLY TITANIUM VERSION)	ZIELONY/ GREEN	MAGENTA	ZIELONY/ GREEN	MAGENTA	ŻÓŁTY/ YELLOW	NATURALNY/ NATURAL	ŻÓŁTY/ YELLOW
							
ŚREDNICA WIERTŁA DRILL DIAMETER	Ø2,0mm	Ø2,2mm	Ø2,0mm	Ø2,2mm	Ø3,0mm	Ø2,5mm	Ø3,0mm
NR KAT WIERTŁA CAT NO OF SCREW	712120	712122	712120	712122	712130	711025	712130
KOLOR WIERTŁA DRILL COLOUR	ZIELONY/ GREEN	MAGENTA	ZIELONY/ GREEN	MAGENTA	ŻÓŁTY/ YELLOW	BRAK KOLORU/ NO COLOUR	ŻÓŁTY/ YELLOW
NR KAT PROWADNICZY WIERTŁA CAT NO OF DRILL GUIDE	075055	075056	750014	075057	075060	750015	075060
KOLOR PROWADNICZY GUIDE COLOUR	ZIELONY/ GREEN	MAGENTA ZIELONY/ GREEN	ZIELONY/ GREEN	MAGENTA ŻÓŁTY/ YELLOW	ŻÓŁTY/ YELLOW	ŻÓŁTY/ YELLOW	ŻÓŁTY/ YELLOW
ROZMIAR KOŃCÓWKI WKRETAKA SCREWDRIVER TIP SIZE	S1,5			S2,5			
NR KAT WKRETAKA CAT NO OF SCREWDRIVER	783115			783125			
KOLOR WKRETAKA SCREWDRIVER COLOUR	ZIELONY/ GREEN			ŻÓŁTY/ YELLOW			

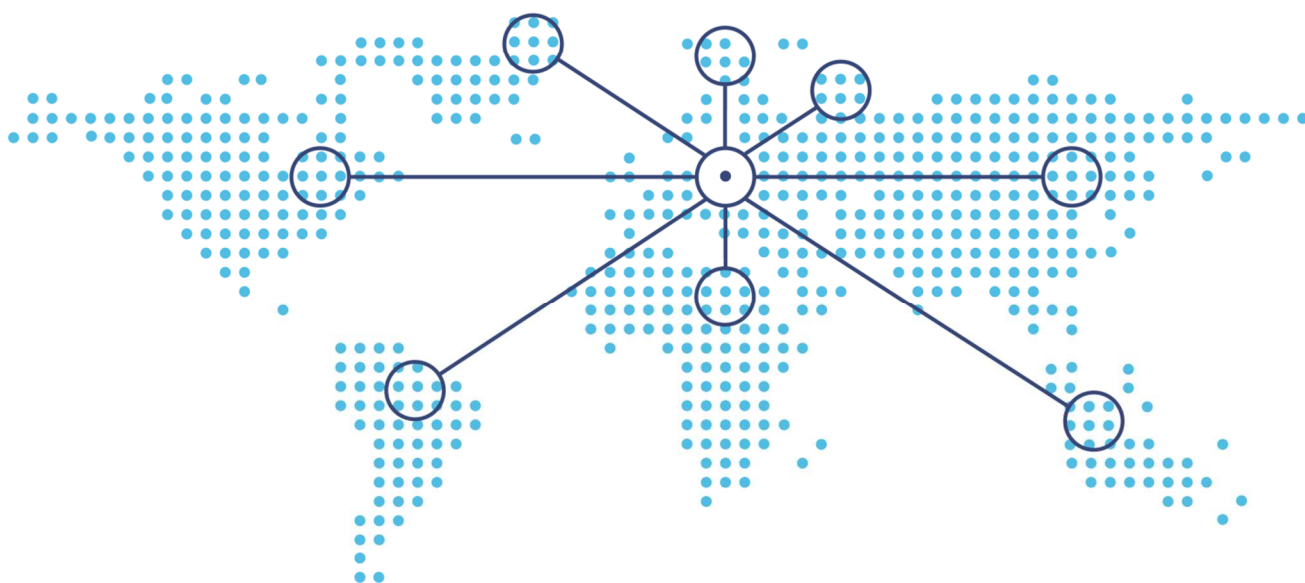

Kontakt Contact

BHH MIKROMED Sp. z o.o.,
ul. Katowicka 11, 42-530 Dąbrowa Górnicza; Poland
tel. /+48 / 32 / 262 52 85,
 /+48 / 32 / 261 02 20,
 /+48 / 505 453 146,
fax /+48 / 32 / 246 68 85,
www.mikromed.pl